

SIEVERT®

Heating Tools for Professionals

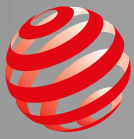

Product Catalogue



reddot design award
winner 2017

Powerjet



DW 3000



Handyjet



“The Red Dot winners are pursuing the right design strategy. They have recognised that good design and economic success go hand in hand. The award by the critical Red Dot jury documents their high design quality and is indicative of their successful design policy.”

Swedish design and quality since 1882

In your hand you hold Sievert's whole product range. But behind all the product pictures and article numbers there is a lot more. This unseen Sievert represents more than hundredthirty years of technical progress - decades of technical support and discussions with users - years of providing thoughtful service - days of unceasing effort to find new possibilities.

Our stated goal is both simple and straightforward: to develop, manufacture and supply innovative and high-quality tools and tool systems for all types of soldering and heating applications. This statement is not just a definition of our product range – it is also a promise. A promise that we will always be one step ahead and that we will always listen to you – our customer – and involve ourselves in your business. A promise that we will be close to hand wherever in the world you may be. A promise that we will be the working partner that you need, helping you achieve the greatest possible success in your business when you use our products and services. Whatever the jobs you may have on today. Whatever the jobs you may have in the future.

We have been in business for more than 140 years, and today our products lead the world. But it still seems that our work has only just begun. Welcome to Sievert.



Carl Richard Nyberg



Max Sievert

The concept is over a hundred years old but the flame still burns as brightly today

Because Carl Richard Nyberg was a specialist in soldering, he knew all too well that the soldering technology available in the 1880's left a lot to be desired. But C. R. Nyberg was a stubborn man determined to find a heating source that would make the work more efficient. After much experimentation at home in his little flat he succeeded in finding a solution and in 1882 he had the first prototype of his soldering blowtorch ready for use, for which he also obtained a patent.

In the same year, the future industrialist **Max Sievert** opened the doors of the machinery business in Stockholm that was to form the foundation of a major company. When the paths of Nyberg and Sievert later crossed, the partnership they created was uncommonly fruitful. Nyberg manufactured blowlamps and Sievert sold them throughout the world. A successful business was launched.



Our products represent today's most advanced technology

But our ambition extends far beyond this!

Wherever you are

Sievert has its origin and head office in Sweden, but with sales in more than 60 countries in five continents, it should be viewed as a truly global business. Few other companies in our industry can boast such geographical coverage.

Our geographical spread also has major benefits for our customers. One is our accessibility and the availability of high standards of service. Another is the experience that we gain of different countries and different industries, which is of immense benefit in our ongoing development work.



Whatever you need

Our goal is to be able to offer professional products at the top end of the quality scale for any possible type of soldering or heating task that needs to be done. Whether the job is large or small and whether you are a demanding professional user or a demanding Do-It-Yourselfer.

It's you who control our work

These days it is not enough to do a good job. You must do the job better, more efficiently and if possible cheaper than anyone else. That is what counts today.

Accordingly, it is vital that we at Sievert understand how you and all our other customers operate – what your daily work involves. In this way we can become a better supplier, providing the products that will best meet the precise requirements of your individual business.

In many cases we have modified products to match specific requests and these have then become part of our standard range of products. This is how you can – and should – control our work, because at the end of the day it is your work that really matters.

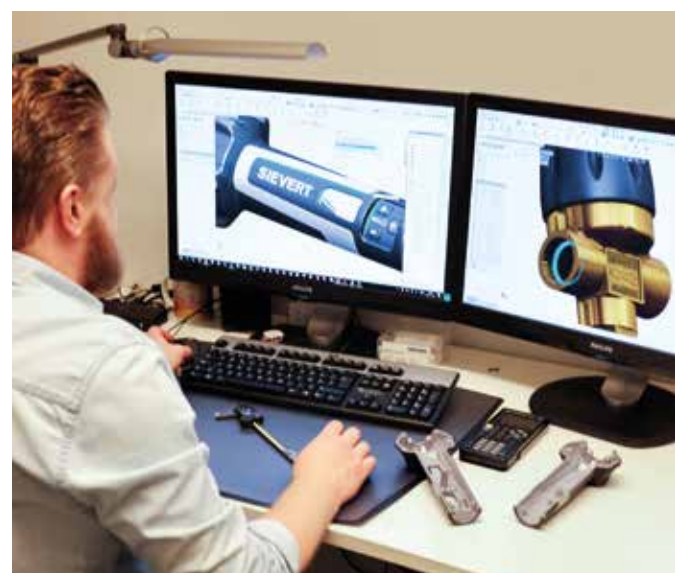



Quality is more than what you see

The piezo igniter is guaranteed for 30,000 operations, and works faultlessly even if the handle is exposed to moisture. Every smallest detail is contrived and machined to function perfectly. We use the very best steel and the most advanced production technology.

Even so, Sievert quality means much more than reliable operation and a long working life. It means knowledge of the user's daily work and long experience of the industry. It means a worldwide organisation. It means the products and range of accessories that make up the whole Sievert System. All this comes as standard for what we call quality.

World leaders – but never satisfied

"Anything good can be made even better" summarises the spirit of our day-to-day work. This doesn't mean that our current products are not as good as we can make them – rather, that we constantly improve our products to match the changing world outside. Being innovative requires more than undertaking technical development for its own sake; it means foreseeing future changes. A good example is our new electronic product range, which complements our established range to make us a complete supplier.







Promatic System
Page 10



Pro 86 System
Page 20



Pro 88 System
Page 28



Soldering Iron Systems
Page 38

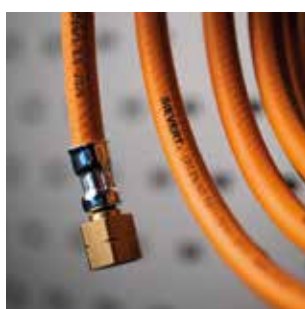

Propane Hoses
Page 44

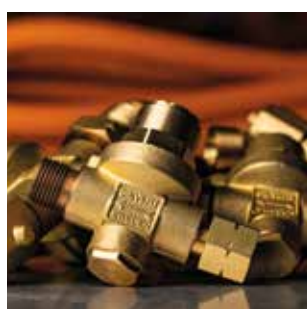

Regulators & HFV
Page 46



Refillable Cylinders
Page 48



Disposable Cartridges
Page 50



Powerjet System
Page 52



Turbojet
Page 60



Handyjet
Page 62



Butajet
Page 64



Grinding Wheel Dressers
Page 67



DW 3000
Page 68



TW 5000
Page 78

LP Gas Information
Page 80

Combination Chart
Page 82

Spare Parts
Page 84

Search Index
Page 86

Accessories/POS
Page 91

Selection Guide

for LP gas heating tools

The System Code

Shows which products that fit together.



Promatic



Pro 86/88



Pro 95



Plastic Welding



Metaljet



Powerjet



Turbojet



Easyjet



The Product Code

Shows the features and benefits of the product.



Piezo ignition



Trigger on/off



Interchangeable burners



360° Anti-Flare



Light-weight



Cyclone flame



Swivel hose nipple



Precise main flame adjustment valve



Precise pilot flame adjustment valve



Precise trigger



Precise main flame adjustment valve

The Application Code

Shows the recommended application for each product.



Soldering



Brazing



Heating



Precision



Shrinking



Waterproofing/
Welding



Paint stripping



Sheet metal



Cyclone flames

The rotating flames wrap around the pipes giving an even heat distribution. Ideal for brazing, soft soldering, plumbing etc.



Pin-point flames

Fine pointed flames with a distinct core. Ideal for fine work on gold, silver, lead etc.



Standard flames

Strong, powerful flames for general soldering and heating.



Power flames

Large powerful, windproof flames for efficient outdoor use. Ideal for roofing, road-working and large scale heating.



Soft flames

Sweeping, powerful flames with visible yellow tip. Ideal for cable work and heat shrinking.



Hot-air flames

Powerful windproof hot-air streams. Ideal for paint stripping, heat shrinking, heating of PVC, roofing etc.



Flat flames

Powerful and windproof wide flame. Ideal for paint stripping, ski waxing etc.

Promatic System

The universal torch system



SAFE

USER FRIENDLY

ERGONOMIC

Promatic is the most complete and advanced system in the Sievert range. The patented piezo ignition, universal handle, range of accessories, advanced design and ergonomic appearance make Promatic a world-beating system for all possible heating tasks where efficiency and professional workmanship are the most important requirements.

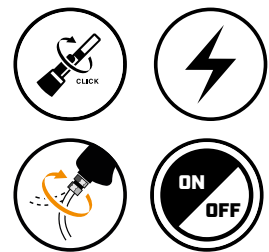

System



Promatic - Sievert's top of the line torch system operates with propane and butane gases.



Soldering



Brazing



Heating



Precision



Shrinking



Waterproofing/
Welding



Paint
stripping



Sheet
metal

- Plastic composite handle reinforced with 30% glass fibres for maximum durability
- Double moulded soft grip for highest comfort and usability
- Piezo igniton with instant trigger on/off function
- Bayonet fitting for burners
- Swivelling hose connection to avoid hose drag
- Combined suspension hook and toolstand
- Valve for precise flame setting
- Delivered without hose nipple



Technical Data

Working pressure (bar)	1,5-4
Weight (g)	290
Length (mm)	180
Height (mm)	80

Hose Connections

Hose Connections	Item No.
BSP 3/8" LH	336611
M14x1	336628
UNF 9/16" LH	336617

Sievert Promatic Universal Handle 3366



Load relieving trigger system with automatic piezo ignition

Trigger on/off function



Swivel hose nipple

Precise flame adjustment valve



Interchangeable burners – no gas emission unless fitted burner

Ergonomic soft grip handle

Built-in hanger



Promatic System

Burners

Burners for Soft Soldering, Brazing and Heating

Pin-point Burners



System



- Pin-point burner with the finest flame for precision work such as gold and silver forging
- Silver soldering about 615 °C
- Working pressure 2 bar

Item No.	333301
Burner diameter Ø (mm)	14
Gas Consumption, g/h at 2 bar	55
Effect (kW)	0,7
Soft Soldering about 400 °C max. pipe diameter Ø (mm)	12
Length (mm)	220
Weight (g)	160

Standard Burners



System



- Standard burners with brush-type flames for all kinds of soft soldering/small heating applications
- Silver soldering about 615 °C
- Working pressure 2 bar

Item No.	334301	334401
Burner diameter Ø (mm)	19	25
Gas Consumption, g/h at 2 bar	250	580
Effect (kW)	3,2	7,4
Soft Soldering about 400 °C max. pipe diameter Ø (mm)	32	70
Length (mm)	210	220
Weight (g)	160	162

Cyclone Burners



System



- Cyclone flame burners are the most efficient burners for brazing and soft soldering
- The rotating flame gives an even and all-round heat transfer to the pipe
- Working pressure 2 bar

Item No.	334001	333501	333601
Burner diameter Ø (mm)	14	19	25
Gas Consumption, g/h at 2 bar	170	250	580
Effect (kW)	2,1	3,2	7,4
Soft Soldering about 400 °C max. pipe diameter Ø (mm)	28	32	70
Brazing up to 720 °C max. pipe diameter Ø (mm)	15	18	32
Length (mm)	150	230	260
Weight (g)	160	180	183

Soft Flame Burners for Cable Shrinking

Promatic

B



System

B



- Soft flame design ideal for cable work and other heat shrinking applications
- Soft flame burners with sweeping, powerful yellow and blue soot-free windproof flames
- Fresh air sucks in and keeps the burner head cold to minimize the risk of burning the shrink material
- To heat the sleeves efficiently but still soft enough not to overheat the shrink material
- Working pressure 2 bar

Item No.	334791	334191	334891
Burner diameter Ø (mm)	28	38	50
Gas Consumption, g/h at 2 bar	460	900	2 000
Effect (kW)	5,9	11,5	26
Length (mm)	240	260	270
Weight (g)	220	255	255
For thick walled sleeves max (mm). Also for thin walled sleeves	50	150	>150

Burners for Paint Stripping (flat flame)



System

B



- Flat flame burner with powerful wide flame for efficient use outdoors for paint stripping and ski-waxing
- Working pressure 2 bar

Item No.	334501
Burner diameter (mm)	40x8
Gas Consumption, g/h at 2 bar	215
Effect (kW)	2,7



Promatic System

Burners

Hot-air Burners for Heat Shrinking and Electronics



System



- Hot-air burners with powerful windproof hot-air streams for heat shrinking
- 3349 ideal for shrinking in confined spaces and fibre optic closures
- Working pressure 2 bar



Item No.	333401	334990
Burner diameter Ø (mm)	38	32x15
Gas Consumption, g/h at 2 bar	125	55
Effect (kW)	1,6	0,7
Length (mm)	285	290
Weight (g)	240	260

Special Burners for PVC and TPO



System



- Hot-air burner with powerful windproof hot-air streams for heating PVC or other rubber membranes where an open flame not is suitable
- Working pressure 2 bar



Perfectly suited to access difficult areas



Item No.	335890
Burner diameter Ø (mm)	32x15
Gas Consumption, g/h at 2 bar	55
Effect (kW)	0,7
Length (mm)	330
Weight (g)	240

Special Burners for Electronics



System



- Extra small hot-air burner incorporating a heat reflector, ideal for signal systems, traffic lights, alarm systems, marine applications, automobiles and other vehicle repairs
- Working pressure 2 bar

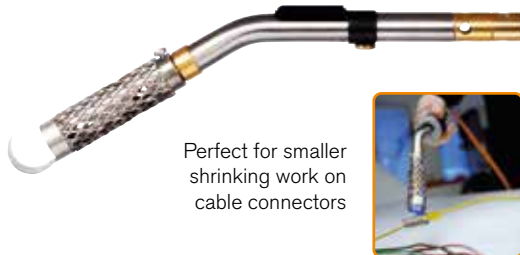

Perfect for smaller shrinking work on cable connectors



Item No.	335990
Burner diameter Ø (mm)	25
Gas Consumption, g/h at 2 bar	28
Effect (kW)	0,36
Length (mm)	275
Weight (g)	260

Soldering Burners for Electronics



System



- Burner with encased and windproof flame for soft soldering.
- Ideal for signal systems, traffic lights, alarm systems, marine applications, automobiles and other vehicle repairs
- Working pressure 2 bar



Item No.	335991
Burner diameter Ø (mm)	10
Gas Consumption, g/h at 2 bar	28
Effect (kW)	0,36
Length (mm)	290
Weight (g)	260

Burners for Waterproofing and Heating

Promatic



Power burners



System



- High capacity power burners with extremely strong and windproof flames for roofing works and for large-scale heating applications
- Long burners for field torching
- Recommended working pressure 4 bar

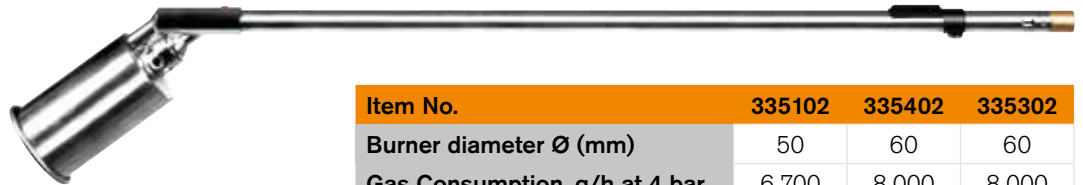

Item No.	335102	335402	335302
Burner diameter Ø (mm)	50	60	60
Gas Consumption, g/h at 4 bar	6 700	8 000	8 000
Effect (kW)	86	102	102
Burner length (mm)	740	600	750
Weight (g)	600	640	720

Power Burners (Titanium)



System



- High capacity power burners with weight reduced by 60% compared to traditional roofing burners on the market
- Highly ergonomic

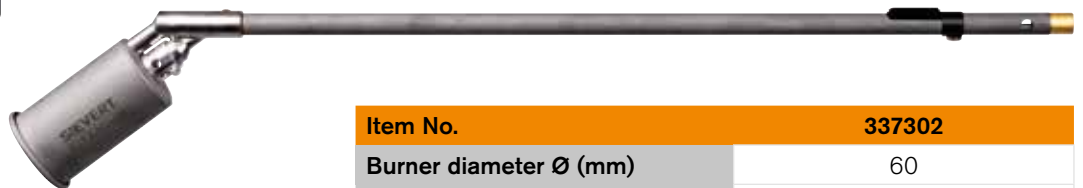

Item No.	337302
Burner diameter Ø (mm)	60
Gas Consumption, g/h at 4 bar	8 000
Effect (kW)	102
Burner length (mm)	760
Weight (g)	460

Detail Power Burners



System



- Short burners for detail work on roofs and other heating applications such as preheating before welding and shrinking on pipeline
- Recommended working pressure 4 bar



Item No.	335002	335602
Burner diameter Ø (mm)	40	60
Gas Consumption, g/h at 4 bar	3 350	8 000
Effect (kW)	43,5	102
Burner length (mm)	380	350
Weight (g)	360	460

Promatic System

Kits

Soft Flame Burner Kit for Heat Shrinking

Heat Shrinking Kit



System



- Promatic kits especially developed for cable and pipeline construction
- The kit includes various heat shrink burners for different heating applications
- Four different models available with various pressure regulators

Item No.	721510	721511	721512	721513
Handle included		336611		
Burners included		334301, 334791, 334191, 334891		
Propane hose included		770025		
Pressure Regulator included	-	306311	753008	309229

Power Burner Kit for Waterproofing and Heating

Titanium Power Burner Kit



System



- Light-weight burner kit with piezo ignition
- Ideal for welding modified bitumen and other heating jobs
- Recommended working pressure 4 bar

Item No.	770173
Gas Consumption, g/h at 4 bar	8 000
Effect (kW)	102
Neck tube length (mm)	500
Burner diameter Ø (mm)	60





Promatic System

Accessories

Copper Bit



- Made of copper with one pointed and one flat end
- For pin-point burner 3333

Item No.	884301
----------	--------

Flat Nozzle



- Flame shaper for hot-air burner 3334

Item No.	716941
----------	--------

Neck Tube Support



- Neck tube support/toolstand for burners with long neck tubes

Item No.	717241
----------	--------

Tool Box



- Made of sturdy metal-reinforced plywood. With large handle and locking clasp. 720106: Space for up to 5 burners, 4 m hose, handle, regulator and two disposable cartridges

Item No.	720106
Dimensions (mm)	260x160x350

Soldering Mat



- For wall and floor protection when soldering
- Saves heat and time
- For temperatures up to 760 °C

Item No.	415061
Dimensions (cm)	25x25

Spanner 17x19



- Open-end wrench 17x19 for all common Sievert hoses and handles









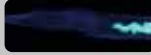

Item No.	701623
Width (cm)	17x19

Canvas Tool Bags

- Sievert tool bags perfect for storing and transporting Promatic or Pro torch kits

Item No.	500012	500013	500014
Dimensions (mm)	500x200x155	900x140x140	1250x160x170



Soldering/ Brazing	Heating	Precision	Shrinking	Waterproofing/ Welding	Sheet metal	Paint stripping
 <p>Cyclone burners for soft soldering and brazing</p> <ul style="list-style-type: none"> 334001 Ø14 mm 333501 Ø19 mm 333601 Ø25 mm 	 <p>Burners for soft soldering</p> <ul style="list-style-type: none"> 333301 Ø14 mm 334301 Ø19 mm 334401 Ø25 mm 	 <p>Pin-point burners</p> <ul style="list-style-type: none"> 333301 Ø14 mm  <p>Cyclone burners</p> <ul style="list-style-type: none"> 334001 Ø14 mm 	 <p>Soft flame burners</p> <ul style="list-style-type: none"> 334791 Ø28 mm 334191 Ø38 mm 334891 Ø50 mm  <p>Hot-air burners</p> <ul style="list-style-type: none"> 335990 Ø25 mm 334990 32x15 mm 333401 Ø38 mm 	 <p>Power burners</p> <ul style="list-style-type: none"> 335002 Ø40 mm 335602 Ø60 mm 335102 Ø50 mm 335302 Ø60 mm 337302 Ø60 mm  <p>Hot-air burners</p> <ul style="list-style-type: none"> 335890 32x15 mm 	 <p>Soldering irons</p> <ul style="list-style-type: none"> 700301 700350 350 g 700500 500 g 700400 400 g 700353 Longlife 350 g 700550 Longlife 500 g 	 <p>Flat flame burners</p> <ul style="list-style-type: none"> 334501 40x8 mm  <p>Hot-air burners</p> <ul style="list-style-type: none"> 334990 32x15 mm 333401 Ø38 mm

Complete your torch kit

Products you need for a complete torch system



336611 3/8" LH
336628 M14x1



 <p>Propane hose 5 mm 2, 4, 10 m</p>	 <p>Propane hose 5 mm 2, 4, 10 m</p>	 <p>Propane hose 5 mm 2, 4, 10 m</p>	 <p>Propane hose 5 mm 2, 4, 10 m</p>	 <p>Propane hose 5 mm Propane hose 8 mm 5 m and 10 m</p>	 <p>Propane hose 5 mm 2, 4, 10 m</p>	 <p>Propane hose 5 mm 2, 4, 10 m</p>
 <p>309221 Regulator, fixed 2 bar, HFV</p>	 <p>309221 Regulator, fixed 2 bar, HFV</p>	 <p>309221 Regulator, fixed 2 bar, HFV</p>	 <p>309221 Regulator, fixed 2 bar, HFV</p>	 <p>306311 Regulator, adjustable 1-4 bar, HFV</p>	 <p>309221 Regulator, fixed 2 bar, HFV</p>	 <p>309221 Regulator, fixed 2 bar, HFV</p>

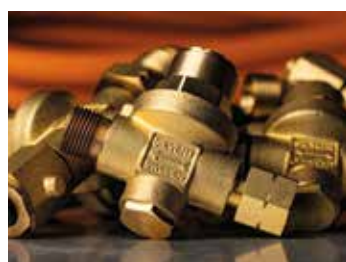

Regulators

For more information, see page 46



Propane hoses

For more information, see page 44

Pro 86 System

The Classic Torch



STABLE FLAME

RELIABLE

The Pro 86 series meets high criterias for carrying out professional heating tasks. Whether it is performing gold/silversmithery, soldering, paint stripping or shrinking, the high quality combined with convenience and a comprehensive range of accessories makes the Pro series a versatile tool for the demanding craftsman.



System



Soldering



Brazing



Heating



Precision



Shrinking



Waterproofing/
Welding



Paint
stripping



Sheet
metal

Pro 86 Handle

Pro 86



- Single valved handle mainly for smaller burners
- The spindle and valve are designed to give a very exact and quick flame setting
- The springloaded metal knob gives a precise and stable setting for the finest of flames
- All metal parts made of high quality brass
- Ergonomically designed plastic composite handle
- Double moulded soft grip for highest comfort and useability
- Delivered without hose nipple



Technical Data	
Working pressure (bar)	1,5-4
Weight (g)	245
Length (mm)	180
Height (mm)	70

Hose Connections	Item No.
BSP 3/8" LH	348641
M14x1	348642
UNF 9/16" LH	348647

Sievert Pro 86 Handle 3486

Exact flame setting
Works in all weather conditions



Wide range of burners for all applications
Two component handle



Sievert Pro 86 Torch Kit

- A professional and powerful torch kit, ideal for soft soldering, brazing, melting, metalworks, paintstripping and other heating jobs
- Includes handle 3486, necktube 3511, burner 2941 and 2 m fixed hose
- Available with or with out valve 700001



Technical Data	
Burner diameter Ø (mm)	28
Gas Consumption, g/h at 2 bar	600
Effect (kW)	7,7
Soft soldering about 400 °C max. pipe diameter Ø (mm)	60

Hose Connections	Item No.
BSP 3/8" LH Fixed hose	219741
BSP 3/8" LH no valve	219742

Pro 86 System

Burners and Neck Tubes

Sievert Pro Neck Tubes

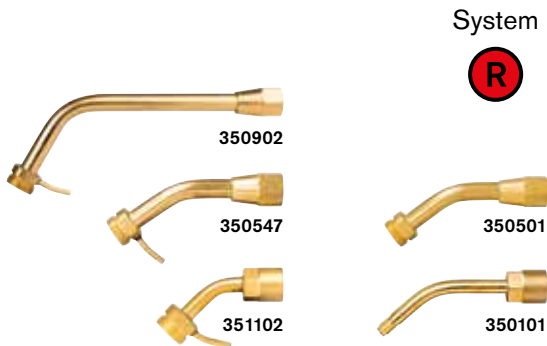

- Neck tubes made of high quality brass
- Shorter neck tubes are recommended for smaller heating applications like gold and silver forging

Item No.	Length (mm)
350902 with hook	180
350501	100
350547 with hook	100
351102 with hook	70
350101 only for burner 8842	78

Soft Flame Burners for Shrinking

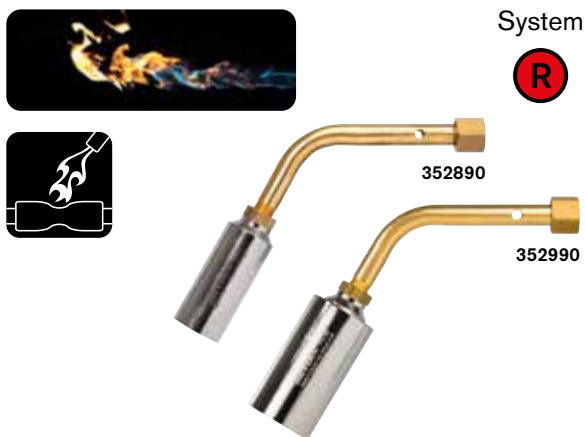

- Soft flame design ideal for cable work and other heat shrinking applications
- Soft flame burners with sweeping, powerful yellow and blue soot-free windproof flames
- Fresh air sucks in and keeps the burner head cold to minimize the risk of burning the shrink material
- To heat the sleeves efficiently but still soft enough not to overheat the shrink material
- For direct connection to Sievert Pro handles
- Working pressure 2 bar

Item No.	352890	352990
Burner diameter Ø (mm)	28	38
Gas Consumption, g/h at 2 bar	900	1 200
Effect (kW)	11,3	15
Connection (handle side)	BSP 3/8" RH	BSP 3/8" RH

Burners for Soft Soldering and Brazing

Pin-point burners



- Pin-point burners with the finest flames for precision work such as gold and silver forging
- Silver soldering about 615 °C
- Recommended working pressure 2 bar

Item No.	393802	393902
Burner diameter Ø (mm)	17	17
Gas Consumption, g/h at 2 bar	20	70
Effect (kW)	0,25	0,9
Soft Soldering about 400 °C max. pipe diameter Ø (mm)	10	12
Connection (neck tube side)	M20x1	M20x1



Standard Burners



System



394002



394102



294102

- Standard burners with brush-type flames for all kinds of soft soldering/small heating applications
- Silver soldering about 615°C
- For connection to Sievert Pro necktubes
- Recommended working pressure 2 bar

Item No.	394002	394102	294102
Burner diameter Ø (mm)	17	22	28
Gas Consumption, g/h at 2 bar	90	240	600
Effect (kW)	1,2	3,1	7,7
Soft Soldering about 400 °C max. pipe diameter Ø (mm)	12	40	60
Connection (necktube side)	M20x1	M20x1	M20x1

Cyclone Burners



System



352403



352503

- Cyclone flame burners are the most efficient burners for brazing, heating and soft soldering
- The rotating flame gives an even and all-round heat transfer to the pipe
- For direct connection to Sievert Pro handles
- Working pressure 2 bar

Item No.	352403	352503
Burner diameter Ø (mm)	19	25
Gas Consumption, g/h at 2 bar	240	800
Effect (kW)	3,1	10,3
Soft Soldering about 400 °C max. pipe diameter Ø (mm)	50	70
Brazing up to 720 °C max. pipe diameter Ø (mm)	18	32
Connection (handle side)	BSP 3/8" RH	BSP 3/8" RH

Special Burners for Paint Removal

Flat Flame Burner



System



- Flat, wide, extremely windproof and powerful flame ideal for paint stripping
- For direct connection to Sievert Pro handles
- Recommended working pressure 2 bar

Item No.	351703
Burner diameter (mm)	35x5
Gas Consumption, g/h at 2 bar	210
Effect (kW)	2,7
Connection (handle side)	BSP 3/8" RH

Pro 86 System

Light Line



Neck Tube

System



- Neck tube to connect Light Line burner to the Pro 86 handle

Item No.	350101
Länge (mm)	78
Connection (handle side)	3/8" LH
Connection (burner side)	M8x0,75

Pin-point Burner

System



884204



872001

- Pin-point burners with the finest flames for precision work such as gold and silver forging
- Silver soldering about 615 °C
- Recommended working pressure 2 bar

Item No.	884204	872001
Gas consumption, g/h at 2 bar	10	60
Max pipe diameter Ø (mm)	8	10
Effect (kW)	0,15	0,75

Standard Burner

System

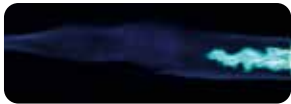

- Standard burners with brush-type flames for all kinds of soft soldering/small heating applications
- Silver soldering about 615 °C
- Recommended working pressure 2 bar

Item No.	871901
Gas consumption, g/h at 2 bar	160
Soft soldering 400 °C, Max pipe diameter Ø (mm)	22
Brazing up to 720 °C, Max pipe diameter Ø (mm)	12
Effect (kW)	2

Power Burner

System



- Heavy duty light weight power burners with extremely strong and windproof flames to withstand the severest weather conditions
- Ideal for brazing, soldering and heating
- Recommended working pressure 2 bar

Item No.	872504
Gas consumption, g/h at 2 bar	550
Soft soldering 400 °C, Max pipe diameter Ø (mm)	40
Brazing up to 720 °C, Max pipe diameter Ø (mm)	18
Effect (kW)	7

Flat Flame Burner

System



- Flat, wide, extremely windproof and powerful flame ideal for paint stripping
- Recommended working pressure 2 bar

Item No.	872304
Gas consumption, g/h at 2 bar	230
Effect (kW)	3

Pro 86 System

Soldering Iron

SIEVERT®

Soldering Iron

Pro 86



System



- Traditional soldering iron burner for sheet metal work
- Practical and sturdy design ▪ Supplied with windshield and burner designed to give excellent wind protection
- Working pressure 2 bar ▪ Delivered without copper bit

Technical Data

Gas Consumption, g/h at 2 bar	260
Effect (kW)	3,3

Hose Connections

Hose Connections	Item No.
BSP 3/8" LH	349241
M14x1	349242



Accessories

Pro 86 Soldering Burner

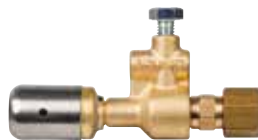

Item No.	295501
Description	Burner unit
Gas Consumption, g/h at 2 bar	260
Effect (kW)	3,3

Pro 86 Windshield



Item No.	708121
Description	Windshield

Copper Bits

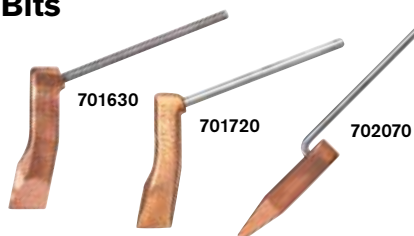

Item No.	701630	701720	702070
Weight (g)	300	500	380

Long Life Copper Bits

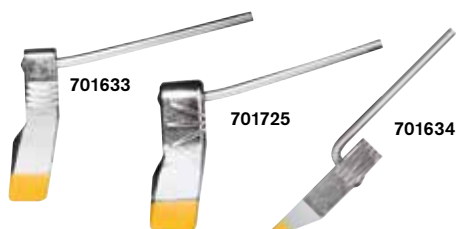





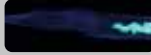

The long-life copperbits have a special coating that protects the copper core from acidic soldering water and solder deposits. Solder up to 1 500 meters without having to reforge or file the copper piece. Taking care of the copper piece is also very easy – Just wipe clean with a damp cloth.

Item No.	701633	701725	701634
Weight (g)	300	500	300





Soldering/ Brazing	Heating	Precision	Shrinking	Waterproofing/ Welding	Sheet metal	Paint stripping
 <p>Cyclone burners for soft soldering and brazing</p> <ul style="list-style-type: none"> 352403 Ø19 mm 352503 Ø25 mm 350101 871901 Ø17 mm 872504 Ø25 mm 	 <p>Burners for soft soldering</p> <ul style="list-style-type: none"> 351102 350902 393802 Ø17 mm 393902 Ø17 mm 394002 Ø17 mm 394102 Ø22 mm 	 <p>Pin-point burners</p> <ul style="list-style-type: none"> 350101 884204 Ø8 mm 872001 Ø12 mm <p>Burners for soft soldering</p> <ul style="list-style-type: none"> 351102 393802 Ø17 mm 393902 Ø17 mm 394002 Ø17 mm 	 <p>Soft flame burners</p> <ul style="list-style-type: none"> 352890 Ø28 mm 352990 Ø38 mm 	 <p>Power burners</p>	 <p>Soldering irons</p> <ul style="list-style-type: none"> 349241 701630 300 g 701720 500 g 702070 380 g 256200 800 g Longlife 701633 300 g Longlife 701725 500 g 	 <p>Flat flame burners</p> <ul style="list-style-type: none"> 351703 35x5 mm 350101 884204

Complete your torch kit

Products you need for a complete torch system



348641 BSP 3/8" LH
348642 M14x1



 <p>Propane hose 5 mm 2, 4, 10 m</p>	 <p>Propane hose 5 mm 2, 4, 10 m</p>	 <p>Propane hose 5 mm 2, 4, 10 m</p>	 <p>Propane hose 5 mm 2, 4, 10 m</p>	 <p>Propane hose 5 mm 2, 4, 10 m</p>	 <p>Propane hose 5 mm 2, 4, 10 m</p>
 <p>309221 Regulator, fixed 2 bar, HFV</p>	 <p>309221 Regulator, fixed 2 bar, HFV</p>	 <p>309221 Regulator, fixed 2 bar, HFV</p>	 <p>309221 Regulator, fixed 2 bar, HFV</p>	 <p>309221 Regulator, fixed 2 bar, HFV</p>	 <p>309221 Regulator, fixed 2 bar, HFV</p>

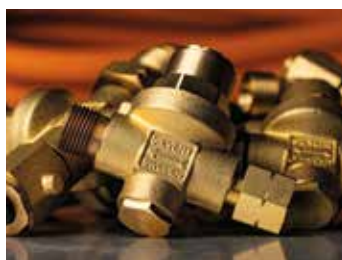

Regulators

For more information,
see page 46



Propane hoses

For more information,
see page 44

Pro 88 System

Heavy-Duty Torch



POWER HEATING

PERFORMANCE

The Pro 88 series is used all over the world by professional roofers and waterproofing specialists. With a complete power burner programme, including Titanium torches, the Pro 88 is the ultimate torch system for heavy-duty work.

The Pro 88 series operates with propane and butane gases.



System



Soldering



Brazing



Heating



Precision



Shrinking



Waterproofing/
Welding



Paint
stripping



Sheet
metal

Pro 88 Handle

Pro 88



- Double valved handle mainly for larger burners
- Incorporates one main valve and one economizer valve enabling a gas saving pilot flame
- Trigger for instant shifting between pilot and main flame and for pulsating the main flame
- All metal parts made of high quality brass
- Ergonomically designed plastic composite handle
- Double moulded soft grip for highest comfort and useability
- Delivered without hose nipple



Technical data

Working pressure (bar)	1,5-4
Weight (g)	385
Length (mm)	205
Height (mm)	90

Hose connections

Hose connections	Item No.
BSP 3/8" LH	348841
BSP 3/8" LH preset pilot flame	348875
M14x1	348842
UNEF 9/16" LH	348847

Sievert Pro 88 Handle 3488



Trigger for shifting between pilot and main flame and for pulsating the main flame



Precise flame adjustment of pilot and main flame
Pilot flame for gas saving
Double valved handle mainly for larger burners



Wide range of burners for power applications
Works in all weather conditions

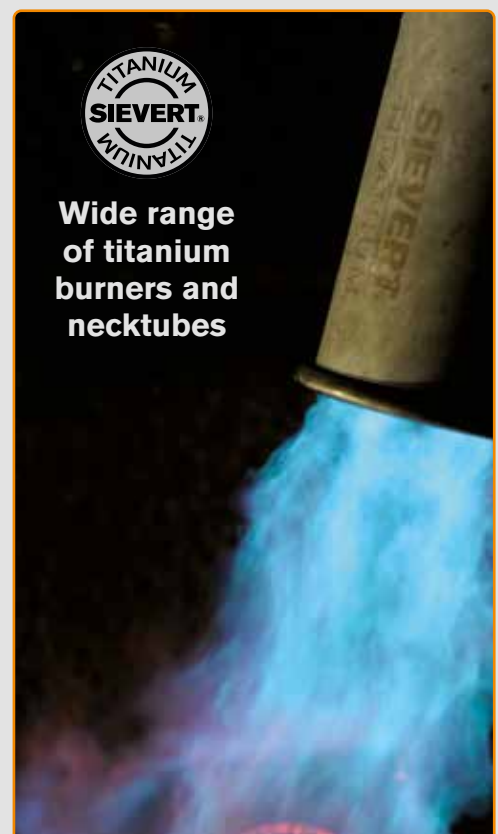

Wide range of titanium burners and necktubes

Pro 88 System

Burners and Neck Tubes

Sievert Pro Neck Tubes

System



- Wide range of neck tubes made of high quality brass
- Double neck tube 770044, made of stainless steel, makes it possible to connect two burners to one neck tube
- Shorter neck tubes like 3505 and 3509 are recommended for smaller heating applications like gold and silver forging
- Longer neck tubes like 3506, 3507, 3508, 3510 are recommended for larger jobs like roofing and road-work

Item No.	Length (mm)
350601	750
350801	600
350701	500
351001	350
350902 with hook	180
350501	100
350547 with hook	100
770044 double neck tube	

Power Burners for Waterproofing and Heat Works

System

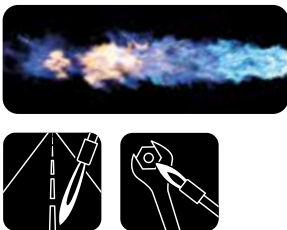

- Heavy-duty light weight power burners with extremely strong and windproof flames to withstand the severest weather conditions
- Ideal for drying, bitumen laying, detail and field torching, preheating before welding, melting snow/ice and other heat demanding applications
- For connection to Sievert Pro necktubes
- Recommended working pressure 4 bar

Item No.	294202	294302	294402
Burner diameter Ø (mm)	32	35	50
Gas consumption, g/h at 4 bar	2 000	3 350	6 700
Effect (kW)	26	43,5	86
Weight (g)	120	130	240
Length (mm)	85	90	110

Made of high quality brass

Item No.	293401	296001
Burner diameter Ø (mm)	34	60
Gas consumption, g/h at 4 bar	2 000	8 250
Effect (kW)	26	114
Weight (g)	140	280
Length (mm)	105	130

Made of high quality stainless steel

Power Burner Torch Kits for Waterproofing

Pro 88



System



Item no.	345000
Burner diameter Ø, mm	50
Gas consumption, g/h at 4 bar	6 700
Effect, kW	86

Swivel hose nipple for 5 to 8 mm hose

Pro 88 Power Burner Kit

System

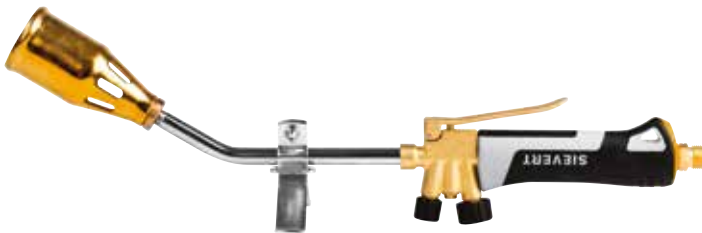

Technical data	
Burner diameter Ø (mm)	50
Gas consumption, g/h at 4 bar	6 700
Effect (kW)	86
Neck tube length, mm	180

Hose connections	Item No.
BSP 3/8" LH	344441
M14x1	344442
UNF 9/16" LH	344447

Pro 88 Stainless Steel Burner Kit

System



Technical data	
Burner diameter Ø, mm	60
Gas consumption, g/h at 4 bar	8 250
Effect (kW)	114
Neck tube length (mm)	500

Hose connections	Item No.
BSP 3/8" LH	346041
M14x1	346042
UNEF 9/16" LH	346047

Special Heavy-Duty Torch 6250

System



Item No.	625010
Burner diameter Ø (mm)	56
Gas consumption, g/h at 4 bar	4 800
Effect (kW)	57
Neck tube length (mm)	400

Hose connection BSP 3/8" LH

Pro 88 System

Titanium Range

Sievert Titanium – Mind your body!



Working long days in tough conditions requires tools that are easy to handle and that prevent state of exhaustion. Sievert Titanium torches are the most ergonomic roofing burners ever created. With weight reduced by 60% compared to traditional burners, they will dramatically reduce the load on your body when working continuously for hours, days and months.

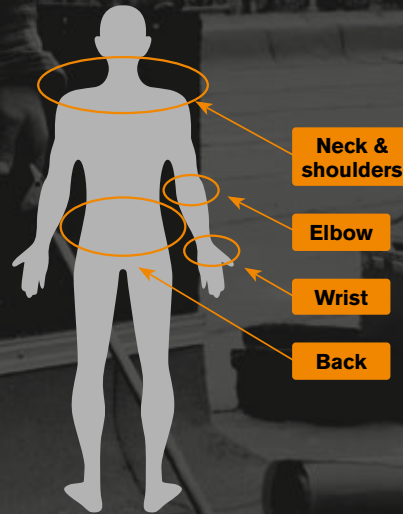

Titanium Power Burners for Waterproofing

Power burners



System



- Heavy-duty light weight power burners with extremely strong and wind-proof flames to withstand the severest weather conditions
- Ideal for drying, bitumen laying, detail and field torching, preheating before welding, melting snow/ice and other heat demanding applications
- For connection to Sievert Pro necktubes
- Recommended working pressure 4 bar



Item No.	295101	295001	295301	295401	295402
Burner diameter Ø (mm)	34	50	60	70	70
Gas consumption, g/h at 4 bar	2 000	6 700	8 250	12 500	12 500
Effect (kW)	26	86	114	155	155

Made of high quality titanium

Titanium Neck Tubes

System



- Range of neck tubes made of high quality titanium to connect power burners



Item No.	355501	355001	355701	355601
Neck tube length (mm)	100	350	500	750

Titanium Power Burner Kits

Pro 88

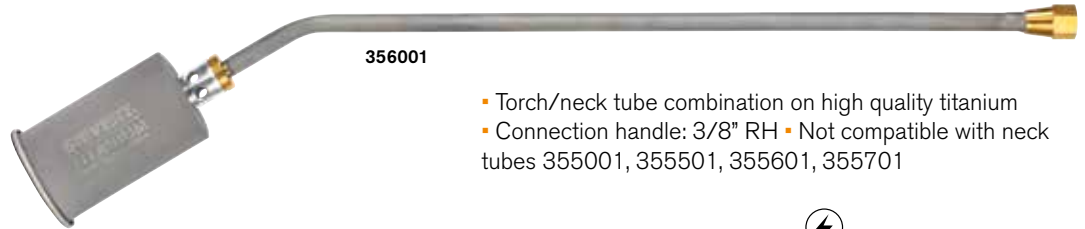

- Torch/neck tube combination on high quality titanium
- Connection handle: 3/8" RH ▪ Not compatible with neck tubes 355001, 355501, 355601, 355701



Item No.	356301	356401	356101	356701	356501	356001	357001	357002	356601	356201
Neck tube length (mm)	100	100	350	350	500	500	500	500	600	750
Burner width (mm)	34	50	50	60	50	60	70	70	50	50
Gas consumption, g/h at 4 bar	2 000	6 700	6 700	8 250	6 700	8 250	12 500	12 500	6 700	6 700
Effect (kW)	26	86	86	114	86	114	155	155	86	86

Power burner torch kits

System

- Complete torch kits with fixed power burners and toolstand

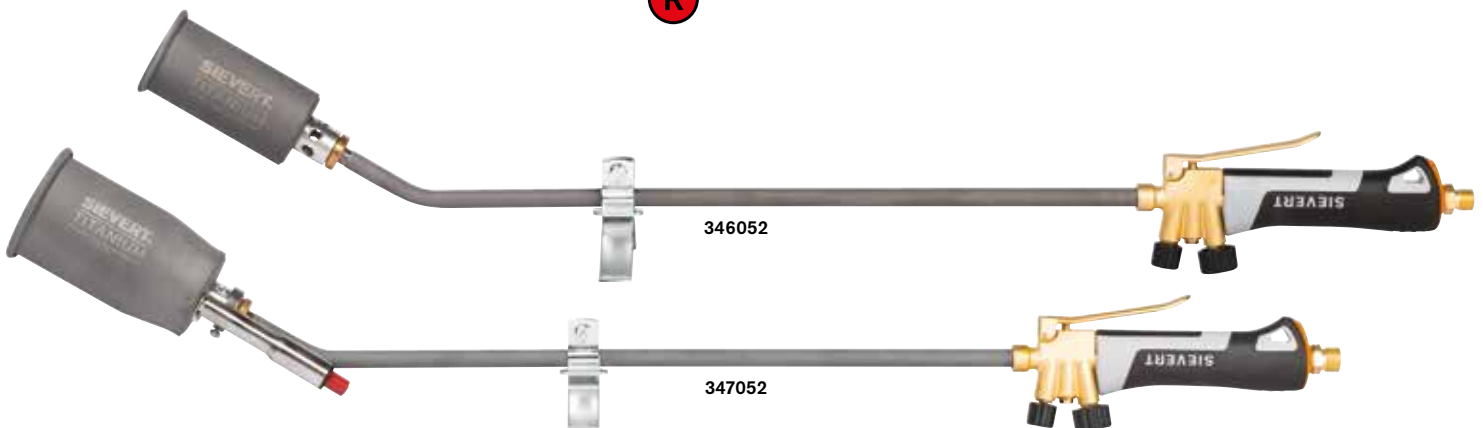

Item No.	346052	346051	347051	347052
Burner diameter Ø (mm)	50	60	70	70
Gas consumption, g/h at 4 bar	6 700	8 250	12 500	12 500
Effect (kW)	86	114	155	155
Neck tube length (mm)	500	500	500	500



Pro 88 System

POS Display Sets



Turboroofer 8 pcs POS Display



System



POS display that is delivered packed and ready to be placed on the shop floor hassle-free. Each display contains 8 pcs of a Pro 88 set packed in a high quality canvas bag.

The Pro 88 sets include everything a user needs from the Pro 88 handle, neck tube, burner, regulator and propane hose.



8 pcs Display Turboroofer Sets

Pro 88



Turboroofers Titanium 60
10 m Hose

NEW!

System



Item No.	346070
Pro 88 Handle	BSP 3/8" LH
Burner diameter Ø (mm)	60
Neck tube length (mm)	500
Hose Failure Valve	BSP 3/8" LH, Shell
Hose	BSP 3/8" LH, Ø 6,3 mm, 10 m

Turboroofers Brass 50
10 m Hose

NEW!

System



Item No.	346071
Pro 88 Handle	BSP 3/8" LH
Burner diameter Ø (mm)	50
Neck tube length (mm)	350
Hose Failure Valve	-
Hose	BSP 3/8" LH, Ø 6,3 mm, 10 m

Turboroofers Titanium 50
10 m Hose

NEW!

System



Item No.	346072
Pro 88 Handle	BSP 3/8" LH
Burner diameter Ø (mm)	60/34
Neck tube length (mm)	500/100
Regulator	POL, 1-4 bar, HFV
Hose	BSP 3/8" LH, Ø 6,3 mm, 10 m
Quick Connection	R 3/8" V, 1 x female, 2 x male

Turboroofers Steel 60
10 m Hose

NEW!

System



Item No.	346074
Pro 88 Handle	BSP 3/8" LH
Burner diameter Ø (mm)	60
Neck tube length (mm)	500
Hose Failure Valve	DIN kombi, 4 bar, HFV
Hose	BSP 3/8" LH, Ø 6,3 mm, 10 m

Pro 88 System

Hot-air Burners



Hot-air Burners for Roofing Work



With lifting device.
Hot-air directed obliquely under overlap.
Supplied with 3488 handle.



Delivered fully prepared for compressed air.

System



- Powerful hot-air roofing burners with totally enclosed flames for efficient bitumen laying when open flames are not permitted
- Powerful enough to achieve the same speed of roof laying compared to open flames - and the gas consumption is much lower
- The use of heat is very efficient due to the narrow and directed hot-air stream and due to the fact that one can work even closer to the material
- All burners can use compressed air to increase power for welding and for quick and efficient drying
- Working pressure 2 and 4 bar





Item No.	298101	298201	298601
Burner width (cm)	8	22	16
Gas consumption, kg/h at 2 bar	1,1	2,2	1,1
4 bar with compressed air	1,8	3,6	1,8
Effect at 2 bar (kW)	15	30	15
Effect at 4 bar (kW)	25	50	25
Connection	BSP 3/8" LH	BSP 3/8" LH	BSP 3/8" LH

Item No. 717271

Allows the use of compressed air to increase the power of hot-air burners 2981 and 2986.



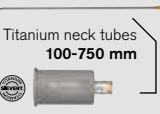
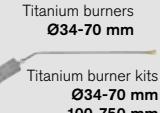
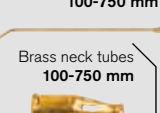
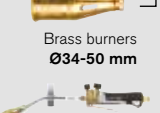
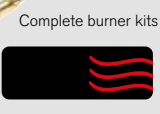

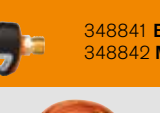
			<p>Soft flame burners</p>  <p>352890 Ø28 mm</p>  <p>352990 Ø38 mm</p>	<p>Power burners</p>  <p>Titanium neck tubes 100-750 mm</p>  <p>Titanium burners Ø34-70 mm</p>  <p>Titanium burner kits Ø34-70 mm 100-750 mm</p>  <p>Brass neck tubes 100-750 mm</p>  <p>Brass burners Ø34-50 mm</p>  <p>Complete burner kits</p> <p>Hot-air burners</p>  <p>298101</p>		
--	--	--	--	--	--	--

Complete your torch kit

Products you need for a complete torch system



348841 BSP 3/8" LH
348842 M14x1



Propane hose
5 mm
2, 4, 10 m



Propane hose 5 mm
2, 4, 10 m
Propane hose 8 mm
5 m and 10 m



309221
Regulator, fixed
2 bar, HFV



306311
Regulator, adjustable
1-4 bar, HFV

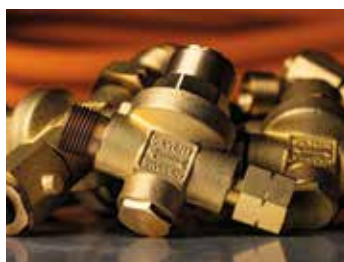

Regulators

For more information,
see page 46



Propane hoses

For more information,
see page 44

Soldering Iron System

Wide Range of Unique Solutions



FLEXIBLE

INNOVATIVE

WIDE RANGE

PSI 3380

System



Sheet metal



System



Pro 95



System



Pro 3492



System



Promatic



Soldering Irons

B



System

B



- Portable soldering iron for sheet metal work made of high quality Titanium and aluminium
- Ergonomically designed handle for even greater comfort
- Automatic piezo ignition
- The burner incorporates an effective windshield that makes the flame totally encased and windproof
- No risk of burning sensitive material
- The precise valve in the handle makes it easy to obtain the right heat for the copper bit
- Copper bit included
- Works 60 to 90 minutes with one 60 g cartridge!

Technical data

Gas Consumption, g/h at 2 bar	75
Effect (kW)	0,9
Length (mm)	230
Weight (g)	810
Copper bit weight (g)	250

Item No. PSI (single unit) **338030**

Item No. PSI kit **338093**

Kit comes in a box with ▪ 1 PSI 338030 ▪ 2 cartridges Ultragas 220283 ▪ 1 Copper bit 700250 (250g) ▪ 2 jet orifices



Accessories



Ergonomically designed handle
Simple one-hand operation



Light-weight design
Made of high quality titanium and aluminum

Copper Bits

- Cold-hammered copper bits made of high-quality electrolytic copper



Item No.	700245	700250
Weight (g)	245	250

Disposable Cartridges

- Ultragas 220283 is a special gas mixture comprising Propane, Butane, Acetone and Propene
- Reaches flame temperatures of more than 2100 °C!

Item No.	220283
Connection	EU 7/16"
Content (ml)	210
Box content (pcs)	12



Anti-flare!

Soldering Iron System

Wide Range of Unique Solutions

Promatic Soldering Iron 3370



System



- Soldering iron burner for sheet metal work made of high quality Titanium
- Ergonomically designed handle for even greater comfort
- Automatic piezo ignition
- The burner incorporates an effective windshield that makes the flame totally encased and windproof
- No risk of burning sensitive material
- Equipped with locking device to keep the flame burning
- The precise valve in the handle makes it easy to obtain the right heat for the copper bit
- Working pressure 2 bar

Delivered without copper bit



Technical Data

Gas Consumption, g/h at 2 bar	140
Effect (kW)	1,8
Length (mm)	290
Weight (g)	832

Hose Connections

Hose Connections	Item No.
BSP 3/8" LH	337030
UNEF 9/16" LH	337037

Accessories

Promatic Titanium Soldering Iron Burner



Item No.	700301
Gas Consumption, g/h at 2 bar	140
Effect (kW)	1,8
Weight (g)	542

Complete Soldering Iron kit



Item No.	337093
Portable soldering kit with 2 disposable Propane cartridges (6 working hours).	
Contains:	
Promatic Soldering Iron with 350 g copper bit	
▪ 2 cartridges of quality propane 430 g, 220883	
▪ Adjustable regulator 265012	
▪ 2 m hose Ø 5 mm, 717321	
▪ Hook for Belt 884105	
▪ Bottle for soldering flux, 757208	
▪ Small brush for soldering flux 757200	
▪ Stone ammoniacal 757206	
▪ Black wooden box 720106	

Copper bits

- Cold-hammered copper bits made of high-quality electrolytic copper



Item No.	700350	700400	700500
Weight (g)	350	370	500

Longlife copper bits

- Long Life Copper bits solder at least 1500 metres and provide maximum heating transfer
- Low gas consumption



Item No.	700353	700550
Weight (g)	350	500

Pro 95 Titanium Soldering Iron

Soldering Irons

K



System

K

- Extra light-weight soldering iron combining classic design, maximum comfort with modern burner technology
- Large selection of copper bits for all kinds of sheet metal work including roofing & gutter soldering
- The Pro 95 burner guarantees wind stability without using a windshield
- The handle has sliding air control to enable hard or soft setting
- Also equipped with a swivel hose connection to avoid hose twist



Technical Data

Gas Consumption, g/h at 2 bar	120
Effect (kW)	1,5
Length (mm)	250
Weight (g)	299

Hose Connections

Item No.

BSP 3/8" LH	770360
M10x1 LH	770361

Accessories



Extreme light-weight design

Made of high quality titanium



Toolstand/
Hanger



Item No.

770303

Copper Bits

- Cold-hammered copper bits made of high-quality electrolytic copper



Item No.	701630	701720	702070
Weight (g)	300	500	380

Long Life Copper Bits

- Long Life Copper bits solder at least 1500 metres and provide maximal heating transfer
- Low gas consumption
- Works 60 to 90 minutes with one 60 g cartridge!



Item No.	701633	701725
Weight (g)	300	500

Soldering Iron System

Wide Range of Unique Solutions

Pro 86 Soldering Iron 3492



System



- Traditional soldering iron burner for sheet metal work
- Practical and sturdy design ▪ Supplied with windshield and burner designed to give excellent wind protection
- Working pressure 2 bar ▪ Delivered without copper bit

Technical Data

Gas Consumption, g/h at 2 bar	260
Effect (kW)	3,3

Hose Connections

Hose Connections	Item No.
BSP 3/8" LH	349241
M14x1	349242



Practical and sturdy design
Precise flame adjustment



Accessories

Pro 86 Soldering Burner



Item No.	295501
Description	Burner unit
Gas Consumption, g/h at 2 bar	260
Effect (kW)	3,3

Pro 86 Windshield

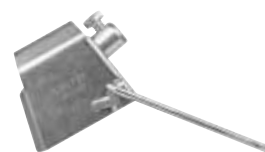

Item No.	708121
Description	Windshield

Copper Bits

- Cold-hammered copper bits made of high-quality electrolytic copper



Item no.	701630	701720	702070
Weight (g)	300	500	380

Long Life Copper Bits

- Long Life Copper solder at least 1500 metres and provide maximal heating transfer ▪ Low gas consumption ▪ Works 60 to 90 minutes with one 60 g cartridge!



Item No.	701633	701725
Weight (g)	300	500

Soldering Irons

PSI



Promatic 3370



Pro 95



Pro 86 3492



Soldering Irons



Soldering Irons

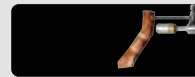

Soldering Irons



Soldering Irons

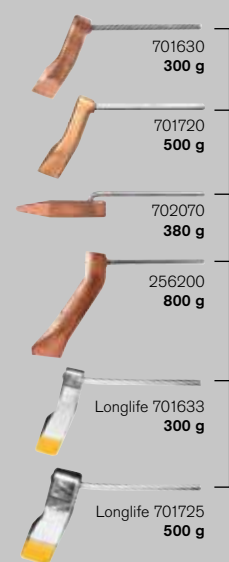

Complete your torch kit

Products you need for a complete torch system



Disposable gas cartridge
Ultragas 220283



Propane hose
5 mm
2, 4 and 10 m



265012
Regulator with
adjustable pressure,
for gas cartridge



309221
Regulator, fixed,
2 bar, HFV



Propane hose
5 mm
2, 4 and 10 m



265012
Regulator with
adjustable pressure,
for gas cartridge



309221
Regulator, fixed,
2 bar, HFV



Propane hose
5 mm
2, 4 and 10 m



265012
Regulator with
adjustable pressure,
for gas cartridge



309221
Regulator, fixed,
2 bar, HFV

Soldering Iron Kit Solutions



Propane hoses

and Accessories



Sievert high pressure hoses conform to the EN ISO 3821 standards. Sievert hoses are also extra frost resistant and can be used in temperatures down to -30 °C. The Sievert hose is designed with three layers – an inner layer of black gas resistant rubber, a middle layer of reinforcing weave to withstand high pressure and an outer orange coloured layer to protect against external damage, sunlight and ozone.

Sievert hoses are available with inside diameters of 4 mm, 5 mm, 6,3 mm and 8 mm in 50 meter rolls or as factory fitted and leak tested hose kits.

Propane Hoses

Diameter 4 mm
EN ISO 3821

Item No.	Hose connection	Handle connection	Connection type	Length (m)
770021	BSP 3/8" LH	BSP 3/8" LH	Fixed	2
770023	BSP 3/8" LH	BSP 3/8" LH	Fixed	3
770024	BSP 3/8" LH	BSP 3/8" LH	Fixed	4
770025	BSP 3/8" LH	BSP 3/8" LH	Fixed	5
770026	BSP 3/8" LH	BSP 3/8" LH	Fixed	10
770031	BSP 3/8" LH	M10x1	Fixed	3
770020	BSP 3/8" LH	BSP 3/8" LH	Fixed	1,5
717420	BSP 3/8" LH	BSP 3/8" LH	Swivel	2
780021	BSP 3/8" LH	BSP 3/8" LH	Swivel	2
701390	BSP 3/8" LH	M14x1	Swivel	4
770034	BSP 3/8" LH	M10x1	Fixed	10
770029	BSP 3/8" LH	M10x1	Fixed	2
770033	BSP 3/8" LH	M10x1	Fixed	5

Propane Hoses

Diameter 5 mm
EN ISO 3821

Item No.	Hose connection	Handle connection	Connection type	Length (m)
853090	-	-	-	50 m roll
717321	BSP 3/8" LH	BSP 3/8" LH	Fixed	2
717341	BSP 3/8" LH	BSP 3/8" LH	Fixed	4
717431	BSP 3/8" LH	BSP 3/8" LH	Fixed	10
701501	BSP 3/8" LH	M14x1	Fixed	2
717320	BSP 3/8" LH	BSP 3/8" LH	Fixed/swivel	2
701294	BSP 3/8" LH	BSP 3/8" LH	Fixed/swivel	4
701505	BSP 3/8" LH	M14x1	Fixed/swivel	2
701290	BSP 3/8" LH	M14x1	Fixed/swivel	4

Propane Hoses for Large Burners

Extra resistant

Diameter 6,3 mm
DIN 4815 6,3 mm

Item No.	Connections	Handle connection	Connection type	Length (m)
770037	BSP 3/8" LH	BSP 3/8" LH	Fixed	5
770038	BSP 3/8" LH	BSP 3/8" LH	Fixed	10
770015	BSP 3/8" LH	BSP 3/8" LH	Fixed	20

Flexible

Diameter 8 mm
EN ISO 3821

Item No.	Connections	Handle connection	Connection type	Length (m)
836990	-	-	-	50 m roll
701295	BSP 3/8" LH	BSP 3/8" LH	Fixed	5
711511	BSP 3/8" LH	BSP 3/8" LH	Fixed	10
701510	BSP 3/8" LH	BSP 3/8" LH	Fixed/swivel	10

Quick Connections

Hoses & Accessories

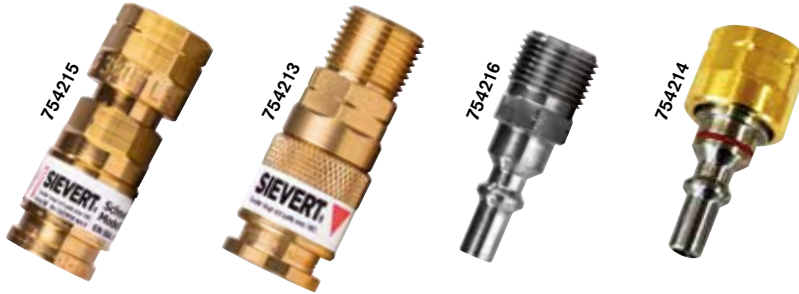

Gas Quick Connection according to EN 561, ISO 7289

- Double O-ring sealing
- Gas cut-off

Threads:

In accordance with EN 560, ISO 3253 or country specific connections: 3/8" LH

Item No.	Description	Connection	Weight (g)	Dimension (mm)
754213	Quick connection OT	G3/8" LH OT	77,3	53x21
754214	Coupling pin IT	G3/8" LH IT	41,8	47x21
754215	Quick connection IT	G3/8" LH IT	86,4	52x21
754216	Coupling pin OT	G3/8" LH OT	29,3	47,5x15

OT=Outside thread IT=Inside thread



Fixed Hose Nipples



Item No.	709621	709180	708971	717000	717020
Thread	BSP 3/8" LH	BSP 3/8" LH	M14x1,5	Shell	POL
Inside hose Ø (mm)	5	5 and 8	5 and 8	5 and 8	5 and 8

Swivel Hose Nipples



Item No.	722001	717331	715161	Item No.	901359	900477
Thread	BSP 3/8" LH	BSP 3/8" LH	M14x1,5	Inside hose Ø (mm)	5	8 adjustable
Inside hose Ø (mm)	5	5 and 8	5 and 8			

Connections

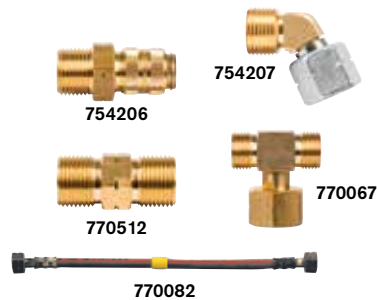

Item No.	Description
754206	Quick connection female, BSP 3/8" LH for hose
754210	Nipple for quick connection male, BSP 3/8" LH for handle
770512	Double nipple, BSP 3/8" LH x BSP 3/8" LH for hose
770067	Connection for connecting two hoses, DIN Kombi
770082	Hose for 770067, length 40 cm, DIN Kombi

Valve Adaptor



Item No.	Description
700001	Valve adaptor M14x1,5/BSP 3/8" LH. Horizontal outlet, convenient swivel connection.

Regulators

Hose Failure Valves



EXTRA SAFETY

STEADY PRESSURE

Sievert regulators are manufactured in brass to ensure the highest quality and long service life. The valves have a very high capacity and precise outlet pressure.

Why use a regulator?

Certain Pro 86/88 burners, such as cyclone burners and most Promatic burners, require a steady pressure of 2 bar in order to perform well. Other burners can also operate under higher pressures but it is still an advantage to reduce the pressure from the propane cylinder. The advantage is that the pressure can be stabilized to obtain the same pressure on a warm summer day as on a cold winter day. The diagram shows how the pressure in an LP-gas cylinder varies with temperature. If the gas output is high, the gas cylinder will be cooled down and the pressure will drop.

Why use a hose failure valve?

A hose failure valve improves safety by cutting off the gas flow in case of a hose rupture or some other major gas leak. The use of hose failure valves is especially recommended on long hoses. The hose connection rotate freely on the valve housing, which reduces the risk of the hose becoming entangled. Sievert hose failure valves are supplied separately (3054) or integrated in regulators (3063, 3083, 3092 and 3093).

Why use LTS?

The Leak Test System improves safety even further. The LTS valve is designed to detect minor leaks. Before starting work, the operator can check for leaks in the system with the LTS valve. Their use is especially recommended in poorly ventilated premises and when working below ground. A regulator with LTS is always combined with a hose failure valve, to take care of the risk from major leaks.

Connections Guide

Commercial name	POL	BSP	Italian	DIN-Kombi	Shell
Thread	0.88"-14NGO	3/8" LH	W20.0-14 LH	W21.8-14 LH	W21.8-14 LH
Standard	G.9	G.25	G.1	G.5	-
Country	CZ, DE, NO, PL, PT, SE	DE	AT, GR, IT	AT, DE, PL, HU	FR
					

Regulators

Regulators with fixed pressure



Item No.	Cylinder connection	Hose connection	Pressure	Max. Capacity
309121	POL	BSP 3/8" LH	2 bar	6 kg/h
309122	BSP 3/8" LH	BSP 3/8" LH	2 bar	6 kg/h
309124	Italian	BSP 3/8" LH	2 bar	6 kg/h
309129	Shell	BSP 3/8" LH	2 bar	6 kg/h
309175	DIN Kombi	BSP 3/8" LH	2 bar	6 kg/h

Regulators with fixed pressure and hose failure valve



Item No.	Cylinder connection	Hose connection	Pressure	Max. Capacity
309221	POL	BSP 3/8" LH	2 bar	4 kg/h
309222	BSP 3/8" LH	BSP 3/8" LH	2 bar	4 kg/h
309225	DIN Kombi	BSP 3/8" LH	2 bar	4 kg/h
309345	DIN Kombi	BSP 3/8" LH	4 bar	12 kg/h
309229	Shell	BSP 3/8" LH	2 bar	4 kg/h
309399	Shell	BSP 3/8" LH	4 bar	12 kg/h

Regulators with adjustable pressure



Item No.	Cylinder connection	Hose connection	Pressure	Max. Capacity
306111	POL	BSP 3/8" LH	1-4 bar	5-20 kg/h
306112	BSP 3/8" LH	BSP 3/8" LH	1-4 bar	5-20 kg/h
306115	DIN Kombi	BSP 3/8" LH	1-4 bar	5-20 kg/h
306119	Shell	BSP 3/8" LH	1-4 bar	5-20 kg/h
With manometer				
308111	POL	BSP 3/8" LH	1-4 bar	5-20 kg/h
308115	DIN Kombi	BSP 3/8" LH	1-4 bar	5-20 kg/h

Regulators with adjustable pressure and hose failure valve



Item No.	Cylinder connection	Hose connection	Pressure	Max. Capacity
306311	POL	BSP 3/8" LH	1-4 bar	5-12 kg/h
306312	BSP 3/8" LH	BSP 3/8" LH	1-4 bar	5-12 kg/h
306314	Italian	BSP 3/8" LH	1-4 bar	5-12 kg/h
306315	DIN Kombi	BSP 3/8" LH	1-4 bar	5-12 kg/h
306319	Shell	BSP 3/8" LH	1-4 bar	5-12 kg/h
With manometer				
308311	POL	BSP 3/8" LH	1-4 bar	5-12 kg/h
308315	DIN Kombi	BSP 3/8" LH	1-4 bar	5-12 kg/h

Regulators with adjustable pressure, hose failure valve and leak test system

Item No.	Cylinder connection	Hose connection	Pressure	Max. Capacity
306961	POL	BSP 3/8" LH	1-4 bar	1-2,3 kg/h
306962	BSP 3/8" LH	BSP 3/8" LH	1-4 bar	1-2,3 kg/h

Regulators with adjustable pressure for cartridges



Item No.	Cylinder connection	Hose connection	Pressure	Max. Capacity
265012	EU 7/16" cartridge	BSP 3/8" LH	0-2 bar	-
265033	US 1" cylinder	BSP 3/8" LH	0-2 bar	-

Hose failure valves with convenient swivelling angled connection



Item No.	Cylinder connection	Hose connection	Pressure	Max. Capacity
305401	POL	BSP 3/8" LH	-	10-14 kg/h
305406	BSP 3/8" LH	BSP 3/8" LH	-	3,8-5,7 kg/h
305402	BSP 3/8" LH	BSP 3/8" LH	-	10-14 kg/h
305404	Italian	BSP 3/8" LH	-	10-14 kg/h
305405	DIN Kombi	BSP 3/8" LH	-	10-14 kg/h
305409	Shell	BSP 3/8" LH	-	10-14 kg/h
645000	POL, hose nipple 5-8 mm		-	14 kg/h

Refillable Cylinders

LP Gas Cylinders



Manufactured from high quality steel, treated with corrosion protection and durable varnish on the outside. Fitted with self closing connecting valves and integrated safety valve. All cylinders are delivered empty.



Item No.	200009	200017	201218	201251	200426	200417
Connection	M14 x1,5	M14 x1,5	M14 x1,5	M14 x1,5	BSP 3/8" LH	BSP 3/8" LH
Total weight (kg)	1,2	1,2	5,7	5,7	1,72	3,3
Contents (kg)	0,34	0,34	2,0	2,0	0,42	0,45
Height (cm)	28	28	22	22	30	36
Safety valve	In valve	In valve	In valve	External	In valve	In valve

Accessories



Item No. 717031
Hose holder for cylinder 2012. A neat and practical solution for carrying and storing a torch kit and hose.



Item No. 884104/884105
Suspension and carrying hook
884104: For use with the 2000, 2004 cylinder.
884105: For use with regulator 265012/265033.

Refillable cylinders

Refill Connections and Accessories for Refillable LP Gas Cylinders



203902

Item No. 203902
Thread: POL / M14x1,5 for cylinder 2000 and 2012



204402

Item No. 204402/204403
204402 Thread: Shell / M14x1,5 for cylinder 2000 and 2012
204403 Thread: DIN Kombi / M14x1,5 for cylinder 2000 and 2012



702621

Item No. 702621
Thread: POL / BSP 3/8" LH for cylinder 2004 and 3960



702871

Item No. 702871
Thread: Shell / BSP 3/8" LH for cylinder 2004 and 3960



770327



757007

Item No. 757007
Thread: DIN Kombi / BSP 3/8" LH for cylinder 2004 and 3960



720740



700001



769200

Item No. 770327
Thread: DIN Household / BSP 3/8" LH for cylinder 2004 and 3960



770326

Item No. 720740/700001//769200
720740: Adaptor for connecting POL regulator to valve - 700001.
Threads - M14x1,5 / BSP 3/8" LH. - 769200: Adaptor POL / DIN Kombi and Shell.

Item No. 770326
BSP 3/8" LH for cylinder 2004.

Light Line

Full range of burners, see page 26



Item No. 871601
Combined valve and neck tube assembly. For use with the refillable cylinder 2000.

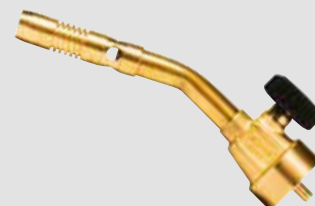

Item No. 881647
Complete torch with US connection. For use with disposable cylinder 2209 and 2211.

Disposable Gas Cartridges



PREMIUM QUALITY

SAFETY

Butane Gas 1925 °C

- Piercable cartridges 221093 without valve
- Cartridge 220183 with adaptors for refilling butajet lighters etc.
- Contains 100% butane

Ultragas 2100 °C

- Built-in Anti-Flare function
- Gas mixture of propane, butane, propylene

Powergas 1925 °C

- Disposable cartridges with self closing valve
- Contains a gas mixture of 35% propane and 65% butane



All Sievert gas products are UFI registered

System			PSI	G	Y	O	O
Item No.	221093	220183	220283	220583	220383	220483	
Connection	Piercable	Filling tube	EU (7/16")	EU (7/16")	EU (7/16")	EU (7/16")	EU (7/16")
Weight (g)	280	256	110	337	257	450	
Contents (g)	190	168	60	210	175	336	
Contents (ml)	350	330	210	380	300	600	
Gas mixture	Butane	Butane	Propane/ Propylene/ Butane	Propane/ Propylene/ Butane	Propane/ Butane	Propane/ Butane	
ADR	UN 2037	UN 2037	UN 2037	UN 2037	UN 2037	UN 2037	UN 2037
Standard	EN 417	EN 417	EN 417	EN 417	EN 417	EN 417	EN 417

Disposable gas

MAPP® and Ultramapp gas 2400 °C For soldering, brazing and heating applications

- Safer, faster, cheaper and easier to work with than Acetylene
- Not sensitive to shocks
- Environmentally friendly and non toxic gas mixture

Premium Quality Propane 1925 °C

- Adapted to most soldering and brazing applications



All Sievert gas products are UFI registered

System	G Y	G Y	G Y	G Y	G Y
Item No.	220685	222183	221183 / *221184	220885	220983 / *220984
Connection	EU (7/16")	EU 7/16"	US (1")	EU (7/16")	US (1")
Weight (g)	536	1200	1200	536	1200
Contents (g)	405	380	400	405	400
Contents (ml)	750	640	788	750	788
Gas mixture	Propylene/ Butane	Propylene	Propylene	Propane/ Butane	Propane
ADR	UN 2037	UN 1077	UN 1077	UN 2037	UN 1978
Standard	EN 417	ISO 11118	EN 12205	EN 417	EN 12205

* For non European markets

* For non European markets



Powerjet System

The Professional Hand-held Torch



FLEXIBLE

PROFESSIONAL

RELIABLE

Flexibility is the key word to describe the Sievert hand-held torch system. These blowtorches provide everything the craftsman or discerning home handyman requires. With many unique features, these are the most advanced blowtorches for brazing or soft soldering, heat-shrinking, heating and dismantling work.

The Powerjet System operates on a number of fuels from propane, butane, propane/butane mix, Sievert Ultragas (a highly efficient anti-flare mixture), MAPP® and Ultramapp for extreme high heat levels.

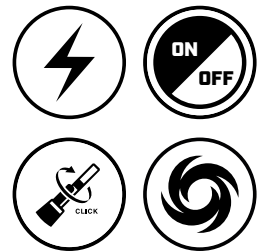

System



Soldering



Brazing



Heating



Precision



Shrinking



Waterproofing/
Welding



Paint
stripping



Sheet
metal

Powerjet

Powerjet



- The most powerful and efficient torch system in the market
- The ergonomic handle is both long lasting and reliable
- Reliable automatic Piezo ignition (up to 30,000 ignitions)
- Trigger on/off function helps preventing LPG wastage
- Anti-Flare enables the torch to operate in all positions (360°)
- Full range of 6 easily interchangeable burners
- Easy exchange of nozzles
- Designed for use with MAPP®, Propane, Ultramapp and Ultragas

Technical Data

Working pressure (bar)	2,0
Weight (g)	290
Length (mm)	180
Height (mm)	80



Modern design and ergonomic 2K comfort grip

Drop protection prevents the connection to break if dropped



Trigger lock provides continuous flame for hands-free use

Trigger on/off function helps preventing LPG wastage



Precise flame adjustment valve – turns only 270°

Piezo ignition – no striker needed



Powerjet System

The Professional Hand-held Torch

Powerjet for Heating, Brazing and Soldering



Connections:



System



Item No.	253501 ⁽¹⁾	253502 ⁽²⁾	253511	253547
Burner included	870601	870601	870601	870701
Burner diameter Ø (mm)	14	14	14	16
Gas consumption at 2 bar (g/h)	170	170	170	230
Effect (kW)	2,2	2,2	2,2	2,9
Connection	M14x1,5	M14x1,5	EU 7/16"	US 1"
Gas cartridge included	-	-	-	-

1) For cylinders 200017, 200019, 200026 & 200060 (2) For cylinders 200032 & 200041

Powerjet Hose Kit

System



- Hose with valve for Powerjet 253501 and 253502
- Powerjet and cylinder not included

Item No.	701262
Length (m)	2
Hose diameter Ø (mm)	5
Handle connection	M14x1
Valve connection	BSP 3/8" LH

Metaljet for Heating and Soldering

Metaljet/Easyjet

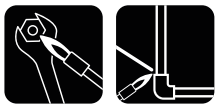

Connections:



EU
7/16"



System



- Metaljet is the heavy duty torch in the Powerjet System
- Reliable automatic Piezo ignition (up to 30 000 ignitions)
- Trigger on/off function helps preventing LPG wastage
- Anti-Flare enables the torch to operate in all positions (360°)
- Full range of 6 easily interchangeable burners
- Easy exchange of nozzles
- Designed for use with Ultramapp but also suitable for use with Propane
- Working pressure 2,0 bar

Item No.	215512
Burner included	870701
Burner diameter Ø (mm)	16
Gas consumption, g/h at 2 bar	230
Effect (kW)	2,9
Connection	EU 7/16"

Easyjet for Soldering, Brazing and Smaller Heating Applications



Connections:



EU
7/16"



US
UNEF 1"

System



- Easy-used, efficient and versatile blowtorch with automatic piezo ignition and fixed burner for both the professional user and the DIY handyman



Item No.	229501	229557	239511
Burner included	870401	870401	870701
Burner diameter Ø (mm)	16	16	16
Gas consumption at 1,5 bar (g/h)	70	70	230 (2 bar)
Effect (kW)	0,9	0,9	2,9
Connection	EU 7/16"	US 1"	EU 7/16"
Gas cartridge included	220483	-	-

Powerjet System

Powercase Kits

Powercase Ultra

System



NEW!

- The kit contains: Powerjet torch handle EU 7/16", cyclone burner 870601, 1 x Ultragas cartridge 220583, toolstand

Item No.	253505
Burner diameter Ø (mm)	14
Gas consumption, g/h at 2 bar	170
Effect (kW)	2,2
Burner included	Cyclone 870601
Connection	EU 7/16"
Gas cartridge included	220583

Powercase MAPP EU

System

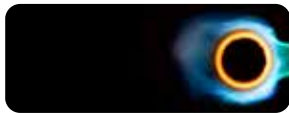

NEW!

- The kit contains: Powerjet torch handle EU 7/16", cyclone burner 870601, 1 x MAPP EU gas cartridge 222183, toolstand

Item No.	253521
Burner diameter Ø (mm)	14
Gas consumption, g/h at 2 bar	170
Effect (kW)	2,2
Burner included	Cyclone 870601
Connection	EU 7/16"
Gas cartridge included	222183

Powercase MAPP US

System



NEW!

- The kit contains: Powerjet torch handle US 1", cyclone burner 870701, 1 x MAPP US gas cartridge 221183, toolstand

Item No.	253583
Burner diameter Ø (mm)	16
Gas consumption, g/h at 2 bar	230
Effect (kW)	2,9
Burner included	Cyclone 870701
Connection	US 1"
Gas cartridge included	221183

Powerjet/Metaljet

Metaljet Roofing Service kit

System



- The kit contains: Metaljet torch handle EU 7/16", soft flame burner 871001, hot-air burner 870801, 2 x MAPP EU gas cartridges 222183, toolstand



NEW!

Item No.	215585
Soft flame burner diameter Ø (mm)	24
Hot-air burner diameter Ø (mm)	38
Gas consumption, g/h at 2 bar	230/130
Effect (kW)	3,5/1,7
Connection	EU 7/16"
Gas cartridge included	222183x2

Empty Powercase with Neutral Label



NEW!

Item No.	600000
Length (mm)	390
Height (mm)	141
Width (mm)	390
Weight (g)	1 920

Powercase 7 pcs POS Display



NEW!



Item No.	253507	253527	253587
Content	7x Powercase 253505	7x Powercase 253521	7x Powercase 253583
Dimensions (mm)	410x410x1205	410x410x1205	410x410x1205
Weight, incl 7 pcs (kg)	21,86	25,22	25,5

Powerjet System

Powerjet Kits

Powerjet Kit

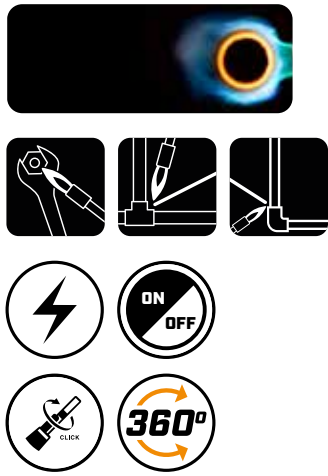

▪ The Powerjet kit 213520 consists of: Powerjet handle 233502 with cyclone burner 870601 and a refillable gas cylinder 200019, all in a metal tool case (763012)

Item No.	213520/213525
Burner diameter Ø (mm)	14
Gas consumption, g/h at 2 bar	170
Effect (kW)	2,2
Burner included	Cyclone 870601
Connection	M14x1,5
Gas cylinder included (empty)	200019

▪ 213525: Kit similar to 213520, but with soldering mat 415061 and filling pipe 204402

Powerjet Ultra Kit

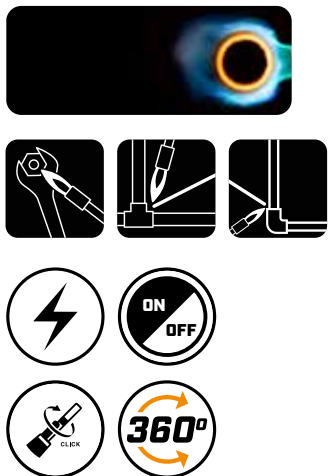

▪ The kit contains: Powerjet torch handle US 1", cyclone burner 870701, 1 x MAPP EU gas cartridge 222183, toolstand

Item No.	253512
Burner diameter Ø (mm)	14
Gas consumption, g/h at 2 bar	170
Effect (kW)	2,2
Burner included	Cyclone 870601
Connection	EU 7/16"
Gas cartridge included	220583

Powerjet Kit 223511

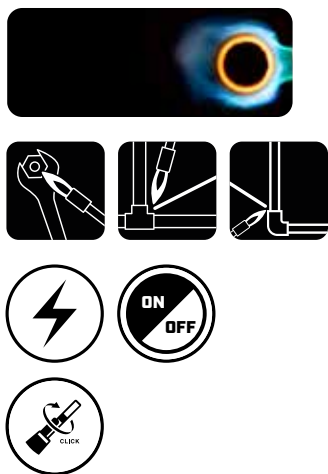

▪ Light-weight composite material handle ▪ Developed for applications such as soft soldering, loosening of bolts, paint stripping, lighting the BBQ ▪ Delivered with standard burner 870401 ▪ Toolstand included ▪ Also works with Powerjet burners 870201 and 870801 ▪ Working pressure 1,5 bar

Item No.	223511	223512
Burner diameter Ø (mm)	16	16
Gas consumption, g/h at 1,5 bar	70	70
Effect (kW)	0,9	0,9
Burner included	870401	870401
Connection	EU 7/16"	EU 7/16"
Gas cartridge included	220483	-

Powerjet System

Interchangeable Burners

Powerjet 



Precision



Soft soldering



Heating



Brazing



Paint stripping



Shrinking

Pin-point burner
870201



- For small soft soldering jobs
- Gives a precise and stable flame

Standard burner
870401



- For soft soldering and other small heating jobs

Cyclone burner
870601

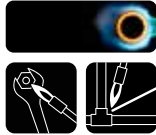

- For brazing and soft soldering
- Intense and efficient short flame that reaches around the pipe

Cyclone burner
870601

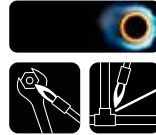

- For brazing and soft soldering
- Highly efficient cyclone burner with increased tip diameter

Hot-air burner
870801

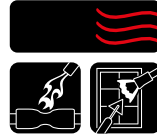

- For shrinking and paint stripping
- Powerful and wind stable hot-air stream

Soft flame burner
871001



- For shrinking and heating jobs
- Powerful and wind stable soft flame



System



Item No.	870201	870401	870601	870701	870801	871001
Burner diameter Ø (mm)	15	16	14	16	38	24
Gas Consumption at 2 bar (g/h)	40	90	170	230	130	230
Effect at 2 bar (kW)	0,5	1,2	2,2	2,9	1,7	3,5
Soldering max pipe Ø (mm)	10	18	40	50	-	22
Brazing max pipe Ø (mm)	-	-	18	20	-	-

Turbojet

Easy-to-use Torch with Swivel Burner for Hands-free Work

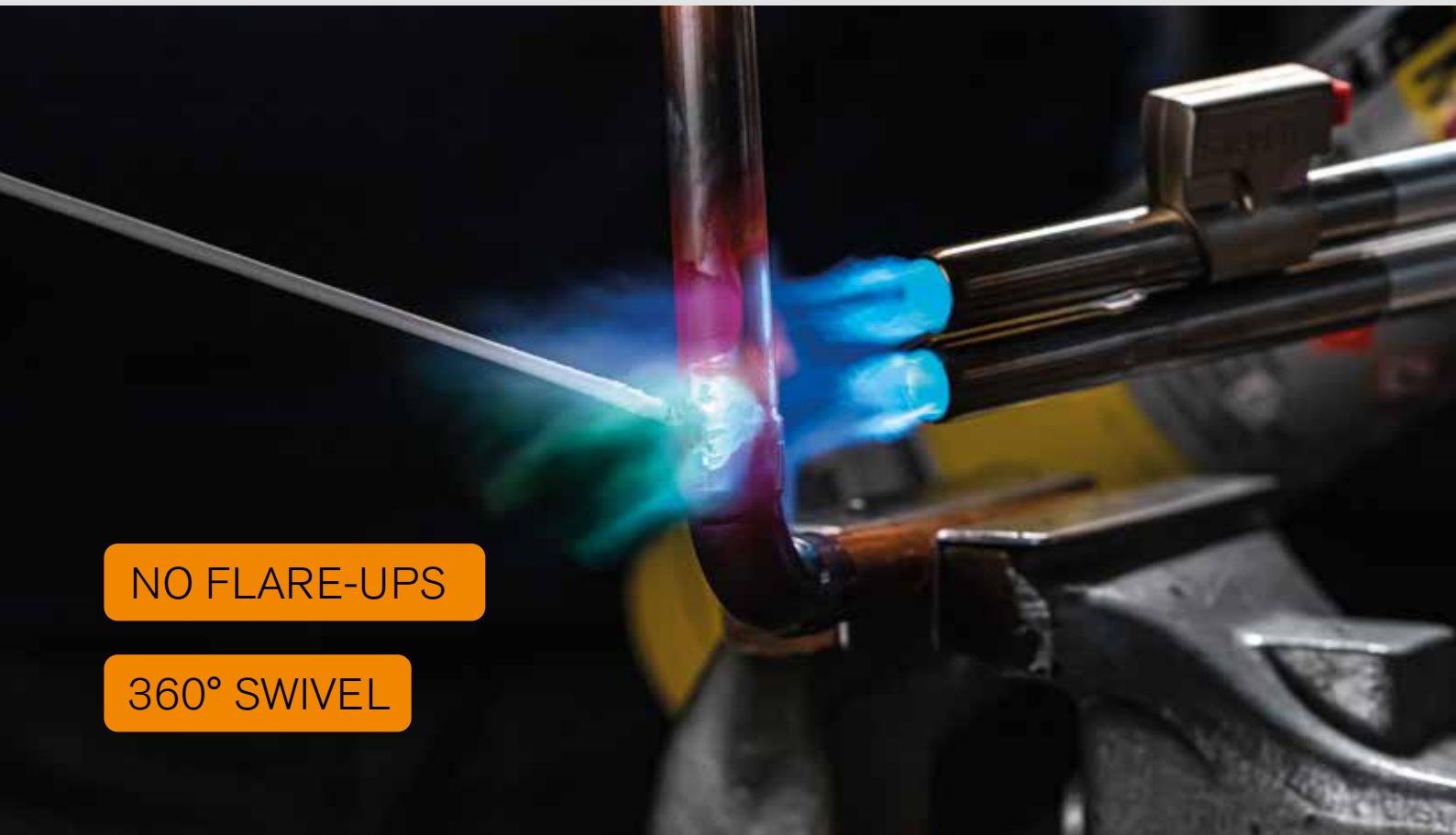

NO FLARE-UPS

360° SWIVEL

Turbojet is engineered with the craftsman in mind. The swivel burner provides 360 degrees of rotation in not one but two different joints, making working areas hard to reach possible.

Aluminum body gives the Turbojet a unique design and makes it 50% lighter than its predecessor.



System



50% lighter



360° swivel burner for areas hard to reach

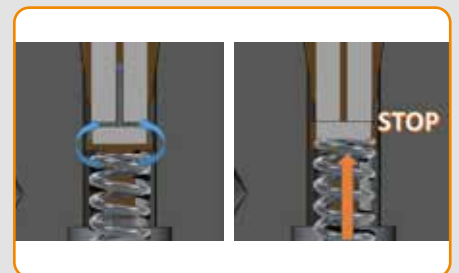

Double gas stop system

Rotating Turbojet Burners

Turbojet



Single Swivel Torch

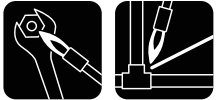

Connections:

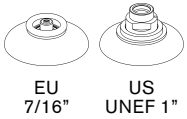

- For all types of brazing and soft soldering, as well as for heating applications

Connections	Item No.
EU 7/16" with piezo	261012
US 1" without piezo	262033
US 1" with piezo	261033

Technical Data	
Working pressure (bar)	0-3,5
Burner diameter Ø (mm)	14
Gas consumption (g/h)	295
Effect (kW)	3,8
Soft soldering max Ø (mm)	40
Brazing max Ø (mm)	18

Twin Swivel Torch



Connections:

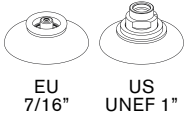

- For (hard) soldering pipes up to Ø 25 mm

Connections	Item No.
EU 7/16" with piezo	264112
US 1" with piezo	264133

Technical Data	
Working pressure (bar)	0-3,5
Burner diameter Ø (mm)	14x2
Gas consumption (g/h)	590
Effect (kW)	7,6
Soft soldering max Ø (mm)	60
Brazing max Ø (mm)	25



Soldering Mat

- For wall and floor protection when soldering
- Saves heat and time
- For temperatures up to 760 °C



Item No.	415061
Dimensions (cm)	25x25

Handyjet

The Multi-purpose Torch



PIEZO IGNITION

ANTI-FLARE

Multi-purpose is the key word for the Handyjet line. Examples of applications are soldering, paint stripping, de-icing, cooking, barberque and many other heating applications.



Handyjet has a powerful, efficient and windstable multi-purpose burner. The unique burner is designed with a pre-heating tube, that heats up the gas before combustion. This means that Handyjet can be used upside down without any flare-ups.



Soldering



Brazing



Heating



Precision



Shrinking



Waterproofing/
Welding



Paint
stripping



Sheet
metal

Handyjet/Jet



Drop protection for maximum safety and durability



Piezo ignition and superior flame adjustment valve



Ergonomic comfort grip

Sievert Jet/Handyjet 2281, 2282 and 2283



Gas cartridges not included
For kits with included gas cartridges, see handyjet kits below.

Item No.	228101	228201	228301
Burner diameter Ø (mm)	20	20	20
Gas consumption (g/h)	140	140	80
Effect (kW)	1,8	1,8	1,0
Piezo ignition	Yes ⚡	Yes ⚡	Yes ⚡
Connection	EU (7/16")	EU (7/16")	Pierceable

Handyjet Kits



Item No.	228102	228202	228203	228302
Burner diameter Ø (mm)	20	20	20	20
Gas consumption (g/h)	140	140	140	80
Effect (kW)	1,8	1,8	1,8	1,0
Piezo ignition	Yes	Yes	Yes	Yes
Connection	EU (7/16")	EU (7/16")	EU (7/16")	Pierceable
Gas Cartridge included	220383	220383	220383x2	221093

Gas

- Recommended disposable gas cartridges



Product name	Butane gas	Powergas
Item No.	221093	220383
Connection	Pierceable	EU (7/16")
Content (ml)	350	300
Gas mix	Butane	Propane/Butane

Butajet

Refillable Torch System



REFILLABLE

HANDY

Turbo Lite Torch 420001



- Gives an exact and wind stable pin-point flame ideal for de-icing of bicycle and car locks, camping or as a cigarette lighter
- Automatic ignition
- Complete portability
- Flame lock child resistant
- Flame temperature 1300 °C
- Burning time per fill 30 minutes

Microjet Torch 423000



- Gives a precise and wind stable pin-point flame Ideal for melting/de-icing of snow and ice, lighting barbeques, candles and small heating works
- Automatic ignition
- Complete portability
- Fueled by butane lighter or included fuel cell
- Flame temperature 1300 °C
- Burning time per fill 20 minutes

Pro Torch 430000



- Gives a precise and adjustable flame ideal for cooking, lighting barbeques and candles also small soldering jobs
- Automatic ignition
- Complete portability
- Hi-tech polymer construction - light weight yet sturdy
- Flame temperature 1300 °C
- Burning time per fill 60 minutes

Butajet

Pro Torch with Rubber Grip 432000

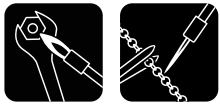

- Gives a stable and adjustable flame ideal for cooking, lighting barbeques and candles also small soldering and shrinking jobs
- Automatic ignition ▪ Complete portability ▪ Ergonomic handle with rubber grip ▪ Removable safety stand included
- Flame temperature 1300 °C ▪ Burning time per fill 220 minutes

Pro Torch Heavy Duty 435000



- Gives a powerful and adjustable flame ideal for cooking, lighting, melting/de-icing, soldering and shrinking jobs ▪ Automatic ignition
- Complete portability ▪ Highest output flame of any butane torch
- Separate Controls for fuel and air ▪ Flame temperature 1350 °C
- Burning time per fill 200 minutes

- For applications such as automotive and truck repairs, TV- and radio repairs, jewelry repairs, electronics, air condition, shrinking and other heating jobs ▪ Automatic piezo ignition ▪ Portable multi function heat tool ▪ Flame temperature 1300 °C

Electric Ignition Soldering Kit 410001



- Power range 30-100 Watt
- Burning time per fill 120 minutes

Premium Soldering Kit 412001



- Power range 30-125 Watt ▪ Visible fuel level
- Burning time per fill 210 minutes

Refilling Cartridge

- Disposable cartridge with self closing valve
- Contains 100% butane
- For refilling of the Butajet line



Item No.	220183
Connection	Filling tube
Weight (g)	256
Content (g)	168
Content (ml)	330
Cartridge	Disposable

Grinding Wheel Dressers





Cleaning and Restoration of Grinding Stones

A worn-out or clogged grinding wheel seriously reduces its grinding ability. With a Sievert Grinding Wheel Dresser, the grinding wheel can be restored to almost new condition and large amount of money will be saved.

The sturdy and comfortable hardwood handle provides a stable but soft grip. The roller comprises complete discs of punched Swedish special steel with U-shaped teeth. Through a special method of hardening, the teeth have been given the correct hardness and toughness. Supporting heels on the dresser cover enable it to be placed precisely against the grinding wheel. The cover also provides protection for the face and hands against sparks and flying particles.

The choice of Sievert Grinding Wheel Dresser depends on the grain size, hardness and speed of the grinding wheel.



Item No.	361208	361108	361008
Grinding wheel max Ø (mm)	500	500	200
Max width (mm)	102	63	38
Max peripheral speed m/s	50	50	30



Item No.	701012	701002	700992
For GWD Item No.	361208	361108	361008
Ø (mm)	56	55	36
Width (mm)	65	39	21

DW 3000

The Revolutionary Hot-Air Tool

POWERFUL

ERGONOMIC

PRECISE



The most advanced and easy-to-use heating tool ever produced by Sievert. System The modern design of the DW 3000 is completely unique and makes this tool the lightest and most ergonomic in its class. The powerful power and precise temperature come from the brushless motor in combination with the latest generation of electronics.

System



The DW 3000 is the most powerful and ergonomic electric hot-air tool on the market!



Ergonomic design

- 30% less weight and more ergonomic than market standard



Superior air pressure and air-flow

- 50% more airflow than market standard



Exact temperature with high precision

- Extremely accurate temperature control

DW 3000



Models

Volt	Item No.
230 V (EU)	293001
120 V (US)	293047
120 V (UK)	293002



Delivered in Powercase

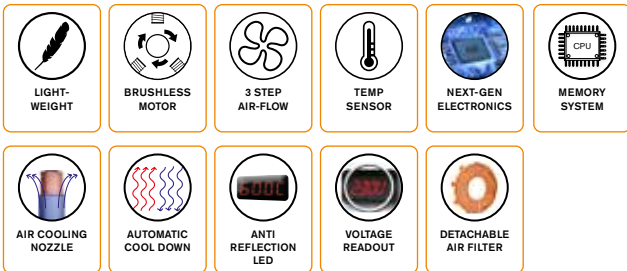

Technical Data											
~ 230 V, 2000 W ~ 120 V, 1700 W	810 g 1.80 lbs	<table border="0"> <tr> <td>III</td> <td>370 l/min</td> <td>Pa 4100</td> </tr> <tr> <td>II</td> <td>340 l/min</td> <td>Pa 3600</td> </tr> <tr> <td>I</td> <td>310 l/min</td> <td>Pa 3100</td> </tr> </table>	III	370 l/min	Pa 4100	II	340 l/min	Pa 3600	I	310 l/min	Pa 3100
III	370 l/min	Pa 4100									
II	340 l/min	Pa 3600									
I	310 l/min	Pa 3100									
50/60 Hz	65 dB	<table border="0"> <tr> <td>III</td> <td>12.7 cfm</td> <td>Pa 4000</td> </tr> <tr> <td>II</td> <td>11.7 cfm</td> <td>Pa 3500</td> </tr> <tr> <td>I</td> <td>10.6 cfm</td> <td>Pa 3000</td> </tr> </table>	III	12.7 cfm	Pa 4000	II	11.7 cfm	Pa 3500	I	10.6 cfm	Pa 3000
III	12.7 cfm	Pa 4000									
II	11.7 cfm	Pa 3500									
I	10.6 cfm	Pa 3000									
100-600 °C 220-1110 °F	3 m 6 ft	<table border="0"> <tr> <td>III</td> <td>Ø 48 mm</td> </tr> <tr> <td>II</td> <td>Ø 1.9 inch</td> </tr> <tr> <td>I</td> <td>330 mm</td> </tr> <tr> <td></td> <td>13.0 inch</td> </tr> </table>	III	Ø 48 mm	II	Ø 1.9 inch	I	330 mm		13.0 inch	
III	Ø 48 mm										
II	Ø 1.9 inch										
I	330 mm										
	13.0 inch										

Accessories

Heating Element



Model	Item No.
DW 3000 (230 V)	297101
DW 3000 (120 V)	297147
DW 3000 (230 V)	297201

Air Filter



Modell	Item No.
DW 3000	297150



DW 3000 Universal

Accessories

Waterproofing Nozzles

- Sievert welding nozzles have a 32 mm connection and can be used on most hot air welders



Item No.	Description	Diameter (mm)
297305	Tubular	ø 5
297320	Angle 15°	20x2
297321	Angle 60°	20x2
297322	Angle 90°	20x2
297340	Flat	40x2
297380	Flat	80x2

Speed Welding Nozzles

- Quick-welding nozzles made of high quality stainless steel. Attachable to nozzle 297305



Item No.	Description	Diameter (mm)
297304	Speed welding round	4 mm
297355	Speed welding round	5 mm
297335	Speed welding triangular	3,7x5,7 mm
297357	Speed welding triangular	5x7 mm
297360	Tacking	-



DW 3000 Universal

Universal Hot-Air Tool

POWERFUL

ERGONOMIC



DW 3000 Universal is the perfect hot-air tool for the professional user who requires both precision and performance in their work.

System



DW 3000 Universal is developed for applications such as cable shrinking, maintenance, repair of plastic, membranes and foil.



Ergonomic design

- 30% less weight and more ergonomic than market standard



Superior air pressure and air-flow

- 50% more airflow than market standard



Exact temperature with high precision

- Extremely accurate temperature control

DW 3000 Universal



Volt	Item No.
230 V (EU)	293101



Delivered in Powercase

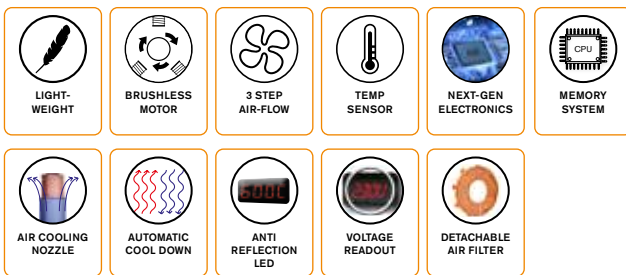

Technical Data		
~ 230 V 2000 W	980 g	III 370 l/min Pa 4100 II 340 l/min Pa 3600 I 310 l/min Pa 3100
50/60 Hz	65 dB	195 mm
100-600 °C	3 m	270 mm

Accessories

Nozzles



Item No.	297315	297328	297370	297505
Description	Reflector	Reflector	Flat	Straight
Dimensions	15 mm	28 mm	70x5 mm	5 mm

Heating Element



Modell	Item No.
DW 3000 (230 V)	297101

Air Filter



Modell	Item No.
DW 3000	297150

Pressure Rollers

Developed for perfect results



Silicone Pressure Rollers



- Silicone pressure roller, for pressing/welding roof membranes
- Shaft fixed with screw
- Ergonomic wooden handle for maximum pressure
- Bracketed on one side

Item No.	Dimensions (mm)	Weight (g)	Model
297512	Ø 33x28	155 g	Straight
297513	Ø 33x45	240 g	Straight
297514	Ø 33x45	240 g	Angled 45°
297515	Ø 33x90	350 g	Straight

Steel Pressure Rollers



- Heavy duty steel pressure roller for cold pressure welding
- Two smooth running ball bearings, riveted axis
- Ergonomic wooden handle for maximum pressure
- Bracketed on one side for overlap welding

Item No.	Dimensions (mm)	Weight (g)	Model
297531	Ø 40x40	490 g	Straight
297532	Ø 40x60	625 g	Straight

PTFE Pressure Rollers



- PTFE roller for overlap welding of much harder and tougher membranes such as polyolefin
- Two smooth running ball bearings
- Screwed axis
- Ergonomic wooden handle for maximum pressure
- Bracketed on one side

Item No.	Dimensions (mm)	Weight (g)	Model
297521	Ø 33x28	165 g	Straight
297522	Ø 33x45	365 g	Straight

Metal Pressure Rollers



- Extra thin metal pressure roller for PVC-sheets welding and flooring installation
- Enclosed smooth-running ball bearings
- Ergonomic wooden handle for maximum pressure

Item No.	Dimensions (mm)	Weight (g)
297541	Ø 34x6	195 g

Brass Pressure Rollers



- Extra thin convex brass pressure roller
- Enclosed smooth-running ball bearings
- Ergonomic wooden handle for maximum pressure

Item No.	Dimensions (mm)	Weight (g)
297542	Ø 28x6	145 g

Seam Tester



- 90° angled seam tester
- Ergonomic wooden handle for maximum pressure
- Optimized tip

Item No.	Dimensions (mm)	Weight (g)
297551	250	100 g

Bitumen Scissors



- Stainless steel scissors
- Thick blade
- Ergonomic plastic grip

Item No.	Blade length (mm)	Weight (g)
297560	110	160 g

Accessories

Hot-air Accessory Kits for Bitumen and PVC

These handy hot-air accessory kits contain all the usual tools required for the processing of thermoplastic or bituminous roofing and sealing membranes. They can also be supplemented with your own accessories.

Want your own compilation? No problem! By using the empty case, you can assemble your individual hot-air accessory kit.

PVC Kit

- Hot air accessory set with standard tools for processing bituminous roofing and sealing membranes

Item No.	293051
Hot-air nozzles	Flat nozzle, 40 mm, 297340, Flat nozzle, 80 mm, 297380
Pressure rollers	Heavy duty steel pressure roller, 60 mm, 297532
Steel scissors	297560
Seam testing hook	297551



Bitumen Kit

- Hot-air accessory kit with standard tools for processing thermoplastic roofing and sealing membranes

Item No.	293052
Hot-air nozzles	Flat nozzle, 40 mm, 297340, Flat nozzle, 80 mm, 297380
Pressure rollers	Heavy duty steel pressure roller, 60 mm, 297532



Neutral Powercase Transport Box

- Empty case for the individual compilation of common hot-air accessory tools.

Item No.	600003
Outer dimensions (mm)	390x190x121



**Stack
& lock!**



TW 5000

Hot-Air Welding Machine

EASY TO OPERATE

POWERFUL



The Sievert TW 5000 was designed with the contractor in mind. It is the most versatile, reliable, powerful and easy to operate automatic hot-air welding machine available on the market.

The Sievert TW 5000 can weld any membrane, such as plastic, rubber and modified bitumen.



Four-wheel drive and belt system assures wrinkle-free welding

- Powerful engine and efficient drive system allows climbing ability up to 30°
- Separate free rolling wheels for easy transport



Easy to operate display unit. Digital display showing temperature, speed and incoming voltage

- Runs on 400 V or 230 V



Powerful fan for high-speed welding

- Adjustable handle made of sturdy steel
- Automatic start/stop sensor when the hot-air nozzle is engaged/disengaged

TW 5000



All models are delivered in a sturdy steel transport box.

Technical Data

Temperature	40 °C-650 °C fully adjustable	Cable length (cm)	90
Speed	0-7 m/min fully adjustable	Dimensions (cm)	56 x 38 x 25
Air-flow	0-48 l/s fully adjustable	Weight (incl. 8 kg)	30 kg
Display	Digital LED	Declaration of conformity	
Emission level	70 dB		

Models

Model 2990

- Overlap welding of PVC and similar roofing membranes



Plastic Welding



Model 2991

- Overlap welding of modified bitumen and similar roofing membrane



Bitumen



Model 2993

- TW 5000 Wideweld, provides a wide nozzle for up to 130 mm welding



130 mm



Item No.	299001	299005	299047	299101	299347
Voltage	400 V ~	220-230 V ~	220-230 V ~	400 V ~	230 V ~
Power	6300 W	5000 W	6300 W	6300 W	6300 W
Ampere	16 A	22 A	28 A	16 A	29 A
Frequency	50/60 Hz	50/60 Hz	50/60 Hz	50/60 Hz	50/60 Hz
Nozzle width (mm)		55		90	
Width of welding seam (mm)		40-55		70-100	120-130

LP Gas Information

Sievert on LP gas

Gaseous paraffins is the correct description for what we call LP gas. LP gas consists of the hydrocarbons propane and butane, or a mixture of the two. These gases are extracted from crude oil. LP gas or LPG stands for liquefied petroleum gas. At normal temperatures, LP gas is gaseous but is a liquid when under pressure. Propane must be distributed in steel cylinders that can withstand high pressure. Butane can be distributed in lighter gas cartridges.

LP gas and safety

Leaking LP gas is a fire hazard.
LP gas is heavier than air.
LP gas uses air during combustion.

There are primarily two things to think about to prevent accidents with LP gas. 1. Avoid leakages. 2. Ensure good ventilation. Leaking LP gas can ignite and cause a fire, or in the worst case, an explosion. The cylinder valve should always be closed when the cylinder is not in use. The cylinder should be stored upright and, if possible, at ground level since LP gas is heavier than air and can therefore accumulate in cellars, manholes etc. Good ventilation is important when working indoors as the flame consumes air. Lack of oxygen causes incomplete combustion, which produces carbon monoxide instead of carbon dioxide. Carbon monoxide is a treacherous and deadly gas.

LP gas and efficiency

Permits very high power outputs.
Energy content is high.
Fuel is easy to store and transport.

A large amount of fuel only occupies a small space and is therefore easy to store and transport. LP gas forms a combustible mixture with air when the proportion of gas is between 2 and 10 percent. When the gas changes from a liquid to a gaseous form, the volume increases by 250 times. In other words, the energy content is high. LP gas can be stored in its container almost indefinitely without the gas breaking down.

LP gas and the environment

LP gas is non-toxic and does not contain hazardous additives.
It does not contaminate air or water.

LP gas does not produce any hazardous combustion gases, just carbon dioxide and water vapor. The gas does not contaminate water, it does not produce soot, it is not corrosive and it does not cause corrosion to iron or other metals. It does not contain lead or heavy metals and is non-toxic. In other words, LP gas is an environmentally friendly fuel. The only additive is a strongly smelling substance that acts as a warning signal for leaking gas. Normally, LP gas has no smell.

LP gas and handling

Work in well-ventilated areas.
Avoid placing the LP gas cylinder near sources of heat.
Ensure that the cylinder is stored upright during transport.

You should regularly check valves and connectors for leakage. Remember also that good ventilation is important at areas where the gas is stored or used. Ventilation is also important to ensure effective combustion. Make sure that the cylinder is at ambient temperature when you begin working. If you are going to use the fuel at temperatures below zero Celsius, use propane instead as butane does not gasify at low temperatures.

LP gas and fire

Always extinguish LP gas fires with powder, never water.
Move LP gas cylinders to a safe place if there is a fire in the vicinity.
If possible, close the valve on the cylinder.

Steel cylinders are fitted with a safety valve that opens if the pressure increases too much. This can occur if there is a fire close to the cylinder. The valve stops the cylinder exploding. To guarantee the function of the safety valve, it is important that the LP gas cylinder is stored in a standing position. In addition, a closed valve stops unchecked gas flow if a hose should become damaged.

LP gas and equipment

Never allow an untrained person to use the equipment.
Only use special LP gas parts.
Be extra careful with valves and connectors.

Never use other valves, burners or hoses that those designed for use with LP gas. Sievert LP gas hose conforms to the EN 559 standard. The hose consists of an internal rubber layer that is LP gas-proof, armouring an external rubber layer that can withstand air and aging. All equipment shown in this product catalogue is manufactured of materials that withstand LP gas and is designed so that the risk for leakage is minimal.

LP gas and checks

Ensure that you have the correct equipment for the job.
Make sure that you have tightened all valves and connectors. Regularly inspect the equipment and check that the system is sealed.

Read the instructions for use and follow the safety advice. Use soapy water or a special liquid for detecting leakages on valves and joints to find any leaks. LP gas hoses should be checked very carefully and changed if you see any changes. Bend the hoses and look for cracks in the rubber. Hoses exposed to sunlight with age quicker than those used indoors.

LP gas and storage

LP gas is not affected by long storage periods. Always disconnect equipment from the container. Store the cylinder in a well-ventilated area.

Avoiding storing LP gas cylinders in areas that are warm. Temperatures below zero Celsius are, however, perfectly safe for storage. Ensure that the ventilation is good. In principle, LP gas can be stored indefinitely in its container without the quality being affected. Remember to remove all connectors before storing the equipment. To empty the system of gas, close the valve on the LP gas cylinder. Then close any valves on the rest of the equipment. In this way, you will avoid LP gas spillage when you open the system again.

LP gas output from a cylinder

When LP gas turns from a liquid to a gas, heat is required which is taken from the liquid itself, from the container and from the surrounding air. LP gas and the bottle become cooler which reduces the pressure in the container. For larger burners, and especially during continuous use, a sufficient container size is necessary so that the burner can work at a constant power. When using larger burners or burners with high gas consumption, ensure the cylinder size is large enough to deliver the required gas, without significant temperature drop. Table (above right) shows an

Temperature	+20 °C	0 °C
Full cylinder 11 kg propane	3,8 kg	1,6 kg
Half cylinder 5,5 kg propane	1,9 kg	0,85 kg

example of the maximum quantity of gas possible to use during an hour for burners requiring 2 bar pressure. Conditions for this example are the following: gas – propane, cylinder size 11 kg, continuous gas use during one hour, temperature of air and cylinder. For large gas burners you need to have big gas cylinders with enough gas or several cylinders linked together.

Temperature of the gas flame

Theoretically, LP gas has a maximum flame temperature of 1925 °C. In practice, this temperature is not reached when heating an object. The temperature achieved depends on the size of the object, how much heat is dispersed, the ability of the burner to transfer heat, the size of the burner and how long the object is heated. Therefore, the choice of burner depends on the job to be carried out.

LP gas and technical specifications

	Butane	Propane
Chemical formula	C ₄ H ₁₀	C ₃ H ₈
Density at 15 °C	Heavier than air	Heavier than air
As gas	2.40 kg/m ³	1.85 kg/m ³
As liquid	0.58 kg/l	0.51 kg/l
Boiling point at atmospheric pressure	-2 °C	-42 °C
Gas pressure at -20 °C	0	1,5 bar
Gas pressure at 0 °C	0	4 bar
Gas pressure at +20 °C	1,3 bar	7,5 bar
Energy content	49.5 MJ/kg 12.6 kWh/kg	50.4 MJ/kg 12.8 kWh/kg
Amount of air required for combustion	12.0 m ³ /kg	12.2 m ³ /kg
Maximum flame temperature with air	1925 °C	1925 °C
Combustion mixtures, volume-% gas in air	1,5-8,5%	2,1-9,5%

Melting points of soldering metals

Soldering metal	Temperature
Tin solder	190-280 °C
Aluminium soft solder	380 °C
Aluminium hard solder	580 °C
Silver solder	610 °C
Phosphor copper solder	720 °C
Bronze solder	860 °C

Melting points of metals

Metal	Temperature
Lead	327 °C
Zinc	419 °C
Aluminium	658 °C
Silver	961 °C
Gold	1063 °C
Copper	1084 °C

Combination Chart

Application code
Shows the applications
for the product



Soldering/Brazing



Heating



Precision

Promatic

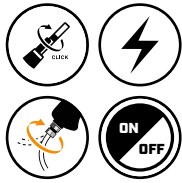

336611
3/8" LH



Cyclone Burners
for soft soldering
and brazing



Burners for
soft soldering



Pin-point
burner

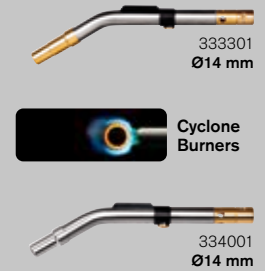

Large
cylinder



Regulator
connection:
Shell, POL,
DIN Kombi,
Italian



Propane hoses
Ø 5, 6,3 8 mm



Regulator
connection:
R 3/8" LH



Valve
700001



Refillable
cylinders
2000/2012



Pro 86



348641



Pro 88



348841



348641/348841/348875
3/8" LH



Cyclone Burners
for soft soldering
and brazing

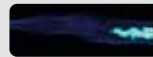
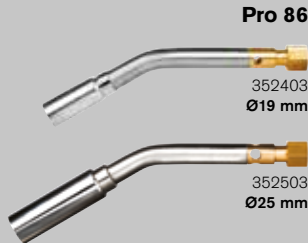

Burners for
soft soldering

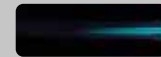
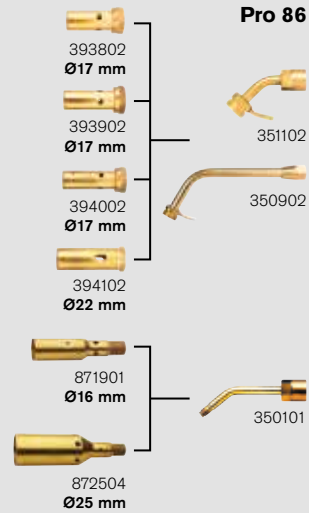

Burners for soft
soldering and
jewelry work

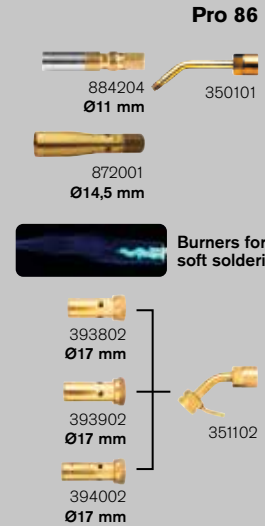

Powerjet



2535



Cyclone Burners
for soft soldering
and brazing

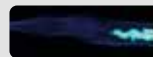
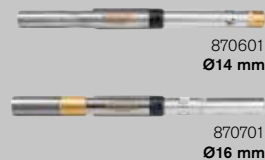

Soft Flame Burners
Standard Burners



Pin-point
Burners



**Easyjet
2295 EU**
Fixed Standard
Burner



Cylinder and
cartridge
connection:

Sievert
M14x1,5



EU 7/16"



US 1"





Shrinking



Roofing/Waterproofing



Sheet Metal



Paint Stripping

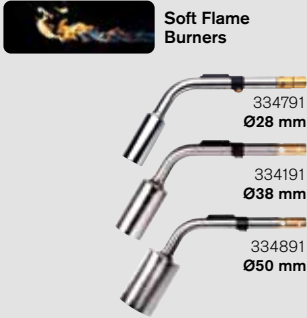

Soft Flame Burners

334791
Ø28 mm

334191
Ø38 mm

334891
Ø50 mm

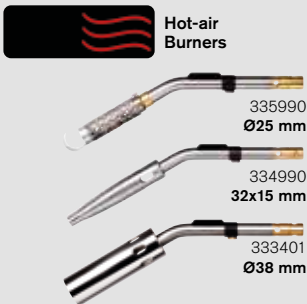

Hot-air Burners

335990
Ø25 mm

334990
32x15 mm

333401
Ø38 mm



Power Burners

335002
Ø40 mm

335602
Ø60 mm

335102
Ø50 mm

335302
Ø60 mm

337302
Ø60 mm



Hot-air Burners

335890
32x15 mm

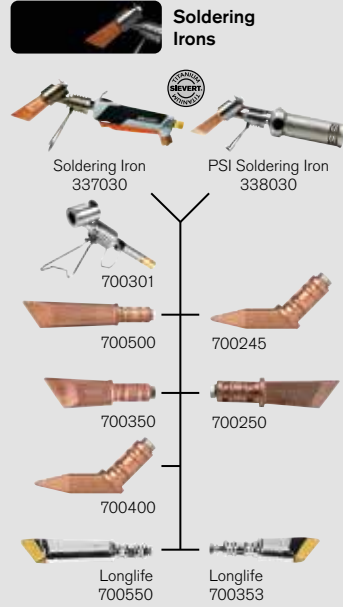

Soldering Irons

Soldering Iron 337030

PSI Soldering Iron 338030

700301

700500

700350

700400

Longlife 700550

700245

700250

Longlife 700353



Flat Flame Burners

334501
40x8 mm

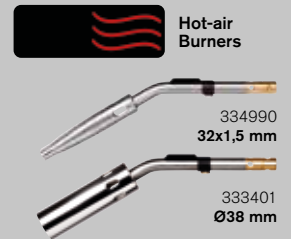

Hot-air Burners

334990
32x1,5 mm

333401
Ø38 mm



Soft Flame Burners

Pro 86

352890
Ø28 mm

352990
Ø38 mm



Power Burners

Pro 88

295101 Ø34 mm

294102 Ø28 mm

295001 Ø50 mm

294202 Ø32 mm

295301 Ø60 mm

293401 Ø34 mm

295402 Ø70 mm

294302 Ø35 mm

294402 Ø50 mm

Neck Tubes Titanium

355501 100 mm

355001 350 mm

355701 500 mm

355601 750 mm

Neck Tubes Brass

350501 100 mm

351001 350 mm

350701 500 mm

350801 600 mm

350601 750 mm

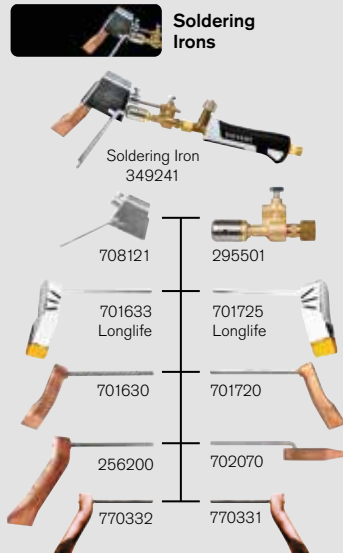

Soldering Irons

Soldering Iron 349241

708121

701633 Longlife

701630

256200

770332

295501

701725 Longlife

701720

702070

770331



Flat Flame Burners

351703
35x5 mm

872304 350101



Hot-air Burners

870801
Ø38 mm

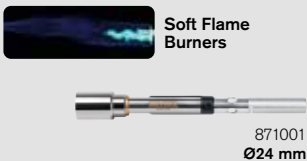

Soft Flame Burners

871001
Ø24 mm



Hot-air Burners

870801
Ø38 mm

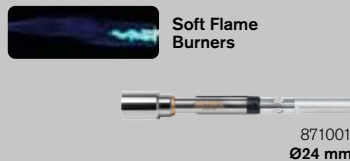

Soft Flame Burners

871001
Ø24 mm



Hot-air Burners

870801
Ø38 mm

716941

Spare parts

Information

Promatic Spare Parts	Item No.
Trigger piezo repair kit	722301
Trigger piezo repair kit for old Promatic handle (336601)	722201
O-ring 9,3 x 2,4 for Promatic burners (5 pcs included)	161291

Pro Spare Parts	Item No.
Small knob for Pro 3488 (5 pcs included)	146227
Large knob for Pro 3488 (5 pcs included)	146221

Pro burner Spare Parts	Item No.
Gasket 19x10x1,5 for 2934, 2941, 2942, 2943, 2944, 2960, 3938, 3939, 3940, 3941 (5 pcs included)	169235
Large knob for Pro 3488 (5 pcs included)	146221

Heavy-duty torch 6250 Spare Parts	Item No.
Knob & Spindle for Heavy-duty torch 652010	625011

PSI Spare Parts	Item No.
O-ring for EU 7/16" connection (2 pcs included)	830806

Regulator Spare Parts	Item No.
Rubber sealing for POL (hand tightening) (5 pcs included)	152588
Gasket for Regulator DIN-Kombi and Shell (5 pcs included)	168912
Gasket for Regulator Italian connection (5 pcs included)	169716

2000 cylinder and valve Spare Parts	Item No.
O-ring for Sievert M14x1,5 connection (2 pcs included)	830606
Gasket for Sievert M14x1,5 connection (2 pcs included)	830306

Powerjet Spare Parts	Item No.
Gasket for Sievert M14x1,5 connection (2 pcs included)	830306
O-ring for Sievert M14x1,5 connection (2 pcs included)	830606
Gasket for US 1" UNEF connection (glue is required) (2 pcs included)	152025
O-ring for EU 7/16" UNEF connection (2 pcs included)	830806
Cartridge and cylinder support for 2000, 2206, 2208, 2209, 2211	700725
Cartridge support for 2203, 2204, 2205, 2206, 2208	700726

Gardener Spare Parts	Item No.
Gasket for Sievert M14x1,5 connection (glue is required) (2 pcs included)	830306
O-ring for Sievert M14x1,5 connection (2 pcs included)	830606
Gasket for US 1" UNEF connection (2 pcs included)	152025
O-ring for EU 7/16" UNEF connection (2 pcs included)	830806
Piezo repair kit	722230

TW 5000 Spare Parts	Item No.
Replacement heating element 400 V ~, 6300 W	799001
Replacement heating element 220-230 V ~, 6300 W	799047
Replacement heating element 220-230 V ~, 5000 W	799007

DW 2000 Spare Parts	Item No.
Heating Element 230 V	297201
Heating Element 120 V	297247



Search Index

Item No.	Product Category	Page	Item No.	Product Category	Page	Item No.	Product Category	Page
200009	Refillable cylinders	48	264133	Turbojet	61	298601	Pro 88	36
200017	Refillable cylinders	48	265012	Regulators	47	299001	TW 5000	79
200417	Refillable cylinders	48	265033	Regulators	47	299005	TW 5000	79
200426	Refillable cylinders	48	293051	Rollers	76	299047	TW 5000	79
201218	Refillable cylinders	48	293052	Rollers	76	299101	TW 5000	79
201251	Refillable cylinders	48	293101	DW 3000	73	299347	TW 5000	79
203902	Refillable cylinders Accessories	49	293401	Pro 88	30	305401	Regulators	47
204402	Refillable cylinders Accessories	49	294102	Pro 86	23	305402	Regulators	47
204403	Refillable cylinders Accessories	49	294202	Pro 88	30	305404	Regulators	47
213520	Powerjet	58	294302	Pro 88	30	305405	Regulators	47
213525	Powerjet	58	294402	Pro 88	30	305406	Regulators	47
215512	Metaljet	55	295001	Pro 88	32	305409	Regulators	47
215585	Metaljet	57	295101	Pro 88	32	306111	Regulators	47
219741	Pro 86	21	295301	Pro 88	32	306112	Regulators	47
219742	Pro 86	21	295401	Pro 88	32	306115	Regulators	47
220183	Cartridges & cylinders	50	295402	Pro 88	32	306119	Regulators	47
220283	Cartridges & cylinders	50	295501	Soldering Irons	25	306311	Regulators	47
220383	Cartridges & cylinders	50	296001	Pro 88	30	306312	Regulators	47
220483	Cartridges & cylinders	50	293001	DW 3000	69	306314	Regulators	47
220583	Cartridges & cylinders	50	293002	DW 3000	69	306315	Regulators	47
220685	Cartridges & cylinders	51	293047	DW 3000	69	306319	Regulators	47
220885	Cartridges & cylinders	51	297101	DW 3000	69	306961	Regulators	47
220983	Cartridges & cylinders	51	297147	DW 3000	69	306962	Regulators	47
220984	Cartridges & cylinders	51	297150	DW 3000	69	308111	Regulators	47
221093	Cartridges & cylinders	50	297201	DW 3000	69	308115	Regulators	47
221183	Cartridges & cylinders	50	297304	Speed welding nozzles	70	308311	Regulators	47
221184	Cartridges & cylinders	51	297305	Nozzles	70	308315	Regulators	47
222183	Cartridges & cylinders	51	297315	Nozzles	73	309121	Regulators	47
223511	Powerjet	58	297320	Nozzles	70	309122	Regulators	47
223512	Powerjet	55	297321	Nozzles	70	309124	Regulators	47
228101	Handyjet	63	297328	Nozzles	73	309129	Regulators	47
228201	Handyjet	63	297322	Nozzles	70	309175	Regulators	47
228202	Handyjet	63	297335	Speed welding nozzles	70	309221	Regulators	47
228203	Handyjet	63	297340	Nozzles	70	309222	Regulators	47
228301	Handyjet	63	297355	Speed welding nozzles	70	309225	Regulators	47
228302	Handyjet	63	297357	Speed welding nozzles	70	309229	Regulators	47
229501	Easyjet	55	297360	Tacking nozzle	70	309345	Regulators	47
229557	Easyjet	55	297370	Nozzles	73	309399	Regulators	47
239511	Easyjet	55	297380	Nozzles	70	333301	Promatic	12
253501	Powerjet	54	297512	Rollers	74	333401	Promatic	14
253505	Powerjet	56	297513	Rollers	74	333501	Promatic	12
253507	Powerjet	57	297514	Rollers	74	333601	Promatic	12
253511	Powerjet	54	297515	Rollers	74	334001	Promatic	12
253512	Powerjet	58	297521	Rollers	75	334191	Promatic	13
253521	Powerjet	56	297522	Rollers	75	334301	Promatic	12
253527	Powerjet	57	297531	Rollers	74	334401	Promatic	12
253547	Powerjet	54	297532	Rollers	74	334501	Promatic	13
253583	Powerjet	56	297541	Rollers	75	334791	Promatic	13
253587	Powerjet	57	297542	Rollers	75	334891	Promatic	13
261012	Turbojet	61	297551	Rollers	75	334990	Promatic	14
261033	Turbojet	61	297560	Scissors	75	335002	Promatic	15
262033	Turbojet	61	298101	Pro 88	36	335102	Promatic	15
264112	Turbojet	61	298201	Pro 88	36	335302	Promatic	15

Item No.	Product Category	Page	Item No.	Product Category	Page
335402	Promatic	15	355601	Pro 88	32
335602	Promatic	15	355701	Pro 88	32
335890	Promatic	14	356001	Pro 88	33
335990	Promatic	14	356101	Pro 88	33
335991	Promatic	14	356201	Pro 88	33
336611	Promatic	11	356301	Pro 88	33
336617	Promatic	11	356401	Pro 88	33
336628	Promatic	11	356501	Pro 88	33
337030	Soldering Irons	40	356601	Pro 88	33
337037	Soldering Irons	40	356701	Pro 88	33
337093	Soldering Irons	40	357001	Pro 88	33
337302	Promatic	15	357002	Pro 88	33
338030	Soldering Irons	39	361008	Grinding-wheel dressers	67
338093	Soldering Irons	39	361108	Grinding-wheel dressers	67
344441	Pro 88	31	361208	Grinding-wheel dressers	67
344442	Pro 88	31	393802	Pro 86	22
344447	Pro 88	31	393902	Pro 86	22
345000	Pro 88	31	394002	Pro 86	23
346041	Pro 88	31	394102	Pro 86	23
346042	Pro 88	31	410001	Butajet	65
346047	Pro 88	31	412001	Butajet	65
346051	Pro 88	33	415061	Accessories	61
346070	Pro 88	34	420001	Butajet	64
346071	Pro 88	34	423000	Butajet	64
346072	Pro 88	34	430000	Butajet	64
346074	Pro 88	34	432000	Butajet	65
346052	Pro 88	33	435000	Butajet	65
347051	Pro 88	33	500012	Accessories	18
347052	Pro 88	33	500013	Accessories	18
348641	Pro 86	21	500014	Accessories	18
348642	Pro 86	21	569106	Accessories	91
348647	Pro 86	23	569107	Accessories	91
348841	Pro 88	29	600000	Powercase	57
348842	Pro 88	29	625010	Pro 88	31
348847	Pro 88	29	645000	Regulators	47
349241	Soldering Irons	25	700001	Regulators	45
349242	Soldering Irons	25	700245	Soldering Irons	39
350101	Pro 86	22	700250	Soldering Irons	39
350501	Pro 86	22	700301	Promatic	40
350547	Pro 86	30	700350	Soldering Irons	40
350601	Pro 88	30	700353	Soldering Irons	40
350701	Pro 88	30	700400	Soldering Irons	40
350801	Pro 88	30	700500	Soldering Irons	40
350902	Pro 86	30	700550	Soldering Irons	40
351001	Pro 88	30	700800	Soldering Irons	32
351102	Pro 86	22	700992	Grinding-wheel dressers	67
351703	Pro 86	23	701002	Grinding-wheel dressers	67
352403	Pro 86	23	701012	Grinding-wheel dressers	67
352503	Pro 86	23	701261	LP Gas propane hoses	36
352890	Pro 86	22	701262	Powerjet	54
352990	Pro 86	22	701290	LP Gas propane hoses	44
355001	Pro 88	32	701294	LP Gas propane hoses	44
355501	Pro 88	32	701295	LP Gas propane hoses	44



Search Index

Item No.	Product Category	Page	Item No.	Product Category	Page
701390	LP Gas propane hoses	44	770026	LP Gas propane hoses	44
701501	LP Gas propane hoses	44	770029	LP Gas propane hoses	44
701505	LP Gas propane hoses	44	770031	LP Gas propane hoses	44
701510	LP Gas propane hoses	44	770033	LP Gas propane hoses	44
701623	Accessories	18	770034	LP Gas propane hoses	44
701630	Soldering Irons	25	770037	LP Gas propane hoses	44
701633	Soldering Irons	25	770038	LP Gas propane hoses	44
701634	Soldering Irons	25	770044	Pro 88	30
701720	Soldering Irons	25	770067	LP Gas propane hoses	45
701725	Soldering Irons	25	770082	LP Gas propane hoses	45
701800	Soldering Irons	33	770173	Promatic	16
702070	Soldering Irons	25	770303	Soldering Irons	41
702621	Refillable cylinders Accessories	49	770326	Refillable cylinders Accessories	49
702871	Refillable cylinders Accessories	49	770327	Refillable cylinders Accessories	49
708121	Pro 86	25	770360	Soldering Irons	41
708971	LP Gas propane hoses	45	770361	Soldering Irons	41
709180	LP Gas propane hoses	45	770512	LP Gas propane hoses	45
709621	LP Gas propane hoses	45	780021	LP Gas propane hoses	44
711511	LP Gas propane hoses	44	836990	LP Gas propane hoses	44
715161	LP Gas propane hoses	45	853090	LP Gas propane hoses	44
716941	Promatic	18	870201	Powerjet	59
717000	LP Gas propane hoses	45	870401	Powerjet	59
717020	LP Gas propane hoses	45	870601	Powerjet	59
717031	Refillable cylinders Accessories	48	870701	Powerjet	59
717241	Accessories	18	870801	Powerjet	59
717320	LP Gas propane hoses	44	871001	Powerjet	59
717321	LP Gas propane hoses	44	871601	Light Line	49
717331	LP Gas propane hoses	45	871901	Light Line	24
717341	LP Gas propane hoses	44	872001	Light Line	24
717420	LP Gas propane hoses	44	872304	Light Line	24
717431	LP Gas propane hoses	44	872504	Light Line	24
720106	Accessories	18	881647	Light Line	49
720730	Regulators	39	884104	Accessories	48
720740	Refillable cylinders Accessories	49	884105	Accessories	48
721510	Promatic	16	884204	Light Line	24
721511	Promatic	16	884301	Accessories	18
721512	Promatic	16	900477	LP Gas propane hoses	45
721513	Promatic	16	901359	LP Gas propane hoses	45
722001	LP Gas propane hoses	45			
754206	LP Gas propane hoses	45			
754210	LP Gas propane hoses	45			
754213	LP Gas propane hoses	45			
754214	LP Gas propane hoses	45			
754215	LP Gas propane hoses	45			
754216	LP Gas propane hoses	45			
757007	Refillable cylinders Accessories	49			
769200	Refillable cylinders Accessories	49			
770015	LP Gas propane hoses	44			
770020	LP Gas propane hoses	44			
770021	LP Gas propane hoses	44			
770023	LP Gas propane hoses	44			
770024	LP Gas propane hoses	44			
770025	LP Gas propane hoses	44			







Canvas Tool Bags



- Sievert tool bags perfect for storing and transporting Promatic or Pro torch kits

Item No.	500012	500013	500014
Dimensions (mm)	500x200x155	900x140x140	1250x160x170

Pallets



Item No.	569107	569106
Dimensions	Half EU pallet 80x60 cm	EU pallet 120x80 cm

POS Displays

Pro 88 Burner Kit

- 8 x Pro 88 kit in toolbag (see page 36)



Powercase Powerjet

- 7 x Powercase of your choice (see page 59)



Other Promotion Material

Rollups
Walls
POS

Contact Sievert

SIEVERT[®]
Swedish design & quality since 1882

SIEVERT AB
P.O Box 1366
SE-171 26 SOLNA
SWEDEN

Telephone: +46 (0)8 629 22 00
Fax: +46 (0)8 629 22 66

E-mail: info@sievert.se
Internet: www.sievert.se